

# **marantz®**

**Model SR4200 User Guide**

---

AV Surround Receiver

## ENGLISH

### WARRANTY

For warranty information, contact your local Marantz distributor.

#### RETAIN YOUR PURCHASE RECEIPT

Your purchase receipt is your permanent record of a valuable purchase. It should be kept in a safe place to be referred to as necessary for insurance purposes or when corresponding with Marantz.

#### IMPORTANT

When seeking warranty service, it is the responsibility of the consumer to establish proof and date of purchase. Your purchase receipt or invoice is adequate for such proof.

#### FOR U.K. ONLY

This undertaking is in addition to a consumer's statutory rights and does not affect those rights in any way.

## FRANÇAIS

### GARANTIE

Pour des informations sur la garantie, contacter le distributeur local Marantz.

#### CONSERVER L'ATTESTATION D'ACHAT

L'attestation d'achat est la preuve permanente d'un achat de valeur. La conserver en lieu sûr pour s'y reporter aux fins d'obtention d'une couverture d'assurance ou dans le cadre de correspondances avec Marantz.

#### IMPORTANT

Pour l'obtention d'un service couvert par la garantie, il incombe au client d'établir la preuve de l'achat et d'en corroborer la date. Le reçu ou la facture constituent des preuves suffisantes.

## DEUTSCH

### GARANTIE

Bei Garantiefragen wenden Sie sich bitte an Ihren Marantz-Händler.

#### HEBEN SIE IHRE QUITTING GUT AUF

Die Quittung dient Ihnen als bleibende Unterlage für Ihren wertvollen Einkauf. Das Aufbewahren der Quittung ist wichtig, da die darin enthaltenen Angaben für Versicherungswecke oder bei Korrespondenz mit Marantz angeführt werden müssen.

#### WICHTIG!

Bei Garantiefragen muß der Kunde eine Kaufunterlage mit Kaufdatum vorlegen. Ihren Quittung oder Rechnung ist als Unterlage ausreichend.

## NEDERLANDS

### GARANTIE

Voor inlichtingen omtrent garantie dient u zich tot uw plaatselijke Marantz.

#### UW KWITANTIE, KASSABON E.D. BEWAREN

Uw kwitantie, kassabon e.d. vormen uw bewijs van aankoop van een waardevol artikel en dienen op een veilige plaats bewaard te worden voor evt. verwijzing bijv. in verbend met verzekering of bij correspondentie met Marantz.

#### BELANGRIJK

Bij een evt. beroep op de garantie is het de verantwoordelijkheid van de consument een gedateerd bewijs van aankoop te tonen. Uw kassabon of factuur zijn voldoende bewijs.

## ESPAÑOL

### GARANTIA

Para obtener información acerca de la garantía póngase en contacto con su distribuidor Marantz.

#### GUARDE SU RECIBO DE COMPRA

Su recibo de compra es su prueba permanente de haber adquirido un aparato de valor. Este recibo deberá guardarlo en un lugar seguro y utilizarlo como referencia cuando tenga que hacer uso del seguro o se ponga en contacto con Marantz.

#### IMPORTANTE

Quando solicitar el servicio otorgado por la garantía el usuario tiene la responsabilidad de demostrar cuándo efectuó la compra. En este caso, su recibo de compra será la prueba apropiada.

## ITALIANO

### GARANZIA

L'apparecchio è coperto da una garanzia di buon funzionamento della durata di un anno, o del periodo previsto dalla legge, a partire dalla data di acquisto comprovata da un documento attestante il nominativo del Rivenditore e la data di vendita. La garanzia sarà prestata con la sostituzione o la riparazione gratuita delle parti difettose.

Non sono coperti da garanzia difetti derivanti da uso improprio, errata installazione, manutenzione effettuata da personale non autorizzato o, comunque, da circostanze che non possano riferirsi a difetti di funzionamento dell'apparecchio. Sono inoltre esclusi dalla garanzia gli interventi inerenti l'installazione e l'allacciamento agli impianti di alimentazione.

Gli apparecchi verranno riparati presso i nostri Centri di Assistenza Autorizzati. Le spese ed i rischi di trasporto sono a carico del cliente.

La casa costruttrice declina ogni responsabilità per danni diretti o indiretti provocati dalla inosservanza delle prescrizioni di installazione, uso e manutenzione dettagliate nel presente manuale o per guasti dovuti ad uso continuato a fini professionali.

## PORTUGUÊS

### GARANTIA

Para informações sobre a garantia, contactar o distribuidor Marantz local.

#### GUARDAR O RECIBO DE COMPRA

O recibo é o registo permanente da compra que fez. Deve ser guardado num local seguro, para ser apresentado em questões relacionadas com o seguro ou para quando tiver de contactar a Marantz.

#### IMPORTANTE

Quando procurar assistência técnica ao abrigo da garantia, é da responsabilidade do consumidor estabelecer a prova e data de compra.

O recibo é prova adequada.

## SVENSKA

### GARANTI

För information om garantin, kontakta Marantz lokalagent.

#### SPAR KVITTOT

Kvittot är ett inköpsbevis på en värdefull vara. Det skall förvaras säkert och hänvisas till vid försäkringsfall eller vidkorrespondens med Marantz.

#### VIKTIGT

Fö att garantin skall gälla är det kundens sak att framställa bevis och datum om köpet. Kvitto eller faktura är tillräckligt bevis för detta.

## DANSK

### GARANTI

Henvend dem til Deres MARANTZ-forhandler angående information om garantien.

#### GEM DERES KVITTERING

Deres købskvittering er Deres varige bevis på et dyrt køb. Den bør gemmes godt og anvendes som bevis, hvis De vil tegne en forsikring, eller hvis De kommunikerer med Marantz.

#### VIGTIGT

Det påhviler forbrugeren at skaffe bevis for købet og købsdatoen, hvis han eller hun ønsker garantiservice. Deres købskvittering eller faktura er et fuldgældigt bevis herpå.

# CE MARKING

- English**  
The SR4200 is in conformity with the EMC directive and low-voltage directive.
- Français**  
Le SR4200 est conforme à la directive EMC et à la directive sur les basses tensions.
- Deutsch**  
Das Modell SR4200 entspricht den EMC-Richtlinien und den Richtlinien für Niederspannungsgeräte.
- Nederlands**  
De SR4200 voldoet aan de EMC eisen en de vereisten voor laag-voltage.
- Español**  
El SR4200 está de acuerdo con las normas EMC y las relacionadas con baja tensión.
- Italiano**  
Il SR4200 è conforme alle direttive CEE ed a quelle per i bassi voltaggi.
- Português**  
O SR4200 conforma com as diretrizes EMC e de baixa voltagem.
- Svenska**  
SR4200 är tillverkad i enlighet med EMC direktiven och direktiven för lågvoltsutrusning.
- Dansk**  
Model SR4200 er i overensstemmelse med EMC-direktivet og direktivet om lavspænding.

## English

To ventilate the unit, do not install the unit in a rack or bookshelf, and note the followings.

- Do not touch the top of the enclosure during operation.
- Do not block the openings in the enclosure during operation.
- Do not insert objects beneath the unit.
- Do not block the ventilation slots at the top of the unit.
- Do not place anything about 1 meter above the top panel.
- Make a space of about 0.2 meter around the unit.

## Français

Pour que l'appareil puisse être correctement ventilé, ne pas l'installer dans un meuble ou une bibliothèque et respecter ce qui suit.

- Ne pas toucher le dessus du coffret.
- Ne pas obstruer les ouïes de ventilation du coffret pendant le fonctionnement.
- Ne placer aucun objet sous l'appareil.
- Ne pas obstruer les ouïes de ventilation du panneau supérieur. Ne placer aucun objet à moins d'un mètre environ du panneau supérieur.
- Veiller à ce qu'aucun objet ne soit à moins de 0,2 mètre des côtés de l'appareil.

## Deutsch

Um eine einwandfreie Belüftung des Geräts zu gewährleisten, darf das Gerät nicht in einem Gestell oder Bücherregal aufgestellt werden; die folgenden Punkte sind besonders zu beachten:

- Während des Betriebs das Oberteil des Gehäuses nicht berühren.
- Während des Betriebs die Öffnungen im Gehäuse nicht blockieren.
- Keine Gegenstände in das Gerät einführen.
- Die Belüftungsschlitze an der Oberseite des Geräts dürfen nicht blockiert werden. Darauf achten, daß über dem Gerät ein Freiraum von mindestens 1 meter vorhanden ist.
- Auf allen Geräteseiten muß ein Zwischenraum von ungefähr 0,2 meter vorhanden sein.

## Nederlands

Installeer het toestel niet in een rek of boekenkast waar de ventilatie mogelijk wordt gehinderd. Let tevens op de volgende punten:

- Raak de bovenkant van het toestel niet aan als het in gebruik is.
- Blokkeer de openingen van het toestel niet als het in gebruik is.
- Plaats geen onderwerpen onder het toestel.
- Blokkeer de ventilatie-openingen aan de bovenkant van het toestel niet. Zorg dat er tenminste 1 meter vrije ruimte boven het toestel is.
- Zorg dat er 0,2 meter vrije ruimte rond het toestel is.

## Español

Para ventilar la unidad no la instale en una estantería ni estante para libros, y tenga en cuenta lo siguiente:

- No toque la parte superior de la caja durante el funcionamiento.
- No tape las ranuras en la caja durante el funcionamiento.
- No ponga objetos debajo de la unidad.
- No tape las ranuras de ventilación de la parte superior de la unidad. No ponga nada a menos de 1 metro por encima del panel superior.
- Deje un espacio de unos 0,2 metro alrededor de la unidad.

## Italiano

Perché l'unità possa essere sempre ben ventilata, non installarla in scaffali o librerie e tenere presente quanto segue.

- Non toccare la parte superiore del rivestimento durante il funzionamento.
- Non bloccare le aperture sul rivestimento durante il funzionamento.
- Non inserire oggetti al di sotto dell'unità.
- Non bloccare le fessure di ventilazione sopra l'unità. Non posare nulla per circa un metro sopra il pannello superiore.
- Lasciare 0,2 metro liberi tutto intorno l'unità.

## Português

Para ventilar o aparelho, não instalá-lo dentro duma estante ou algo similar, e observar as seguintes recomendações:

- Não tocar a parte superior do aparelho durante a operação.
- Não bloquear as aberturas do aparelho durante a operação.
- Não inserir objectos debaixo do aparelho.
- Não bloquear as aberturas de ventilação na parte de cima do aparelho. Deixar um espaço completamente livre de cerca de 1 metro acima do painel superior.
- Deixar um espaço de cerca de 0,2 metro ao redor do aparelho.

## Svenska

För att ventilera enheten, ställ den inte i ett ställ eller bokhylla och tänk på följande.

- Vidrör inte ytterhöljets ovansida under pågående drift.
- Blockera inte öppningarna i ytterhöljet under pågående drift.
- Stick inte in föremål under enheten.
- Blockera inte ventilationshålen ovanpå enheten. Placera inte någonting närmare än 1 meter ovanför apparaten eller enheten.
- Se till att det finns omkring 0,2 meter fri plats runt omkring enheten.

## Dansk

Anbring ikke apparatet i et rack eller en boghylde, da dette kan bloke luftcirkulationen omkring apparatet. Iagttag ligeledes følgende:

- Berør ikke oversiden af kabinettet under anvendelsen.
- Bloker ikke åbningerne i kabinettet under anvendelsen.
- Stik ikke genstande ind under apparatet.
- Bloker ikke ventilationsåbningerne ovenpå apparatet. Anbring ikke noget nærmere end 1 m over apparatets overside.
- Sørg for, at der er et frit område på omkring 0,2 m omkring apparatet.

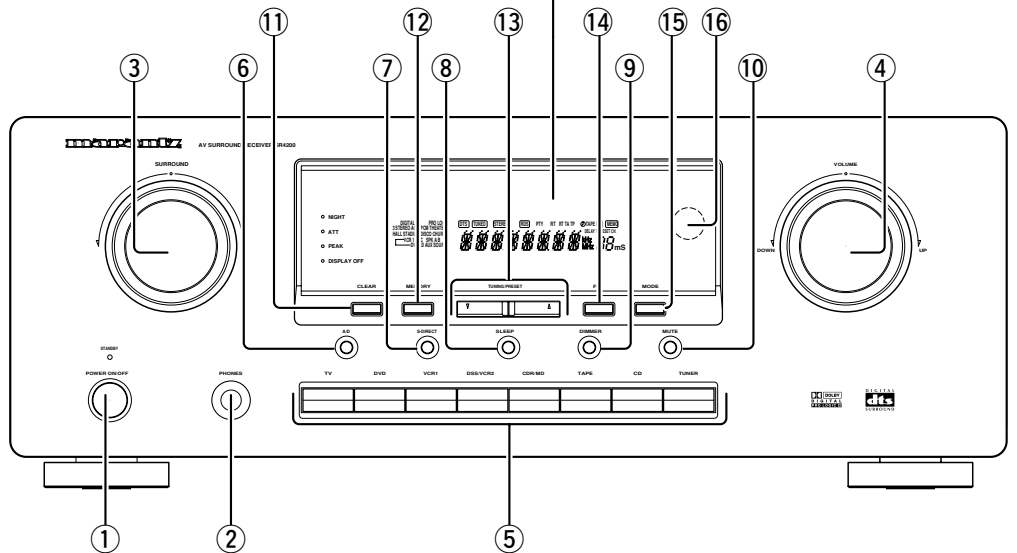
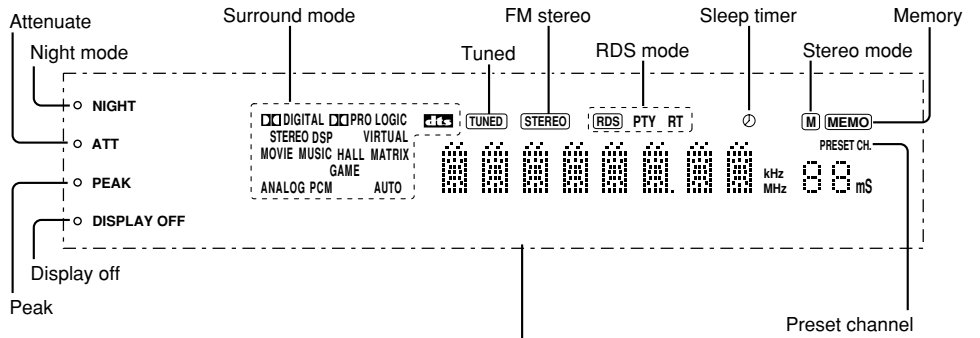
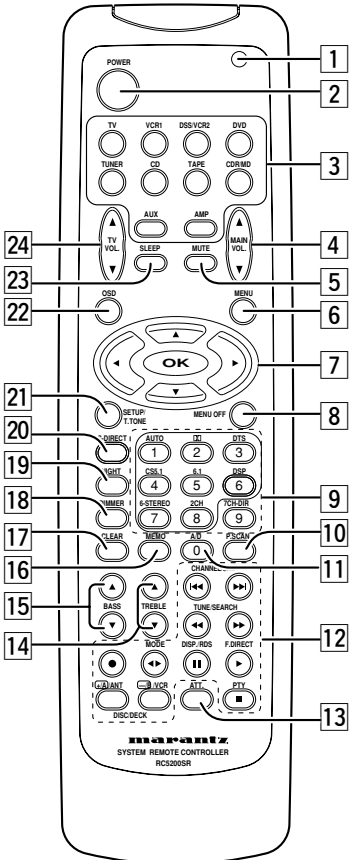
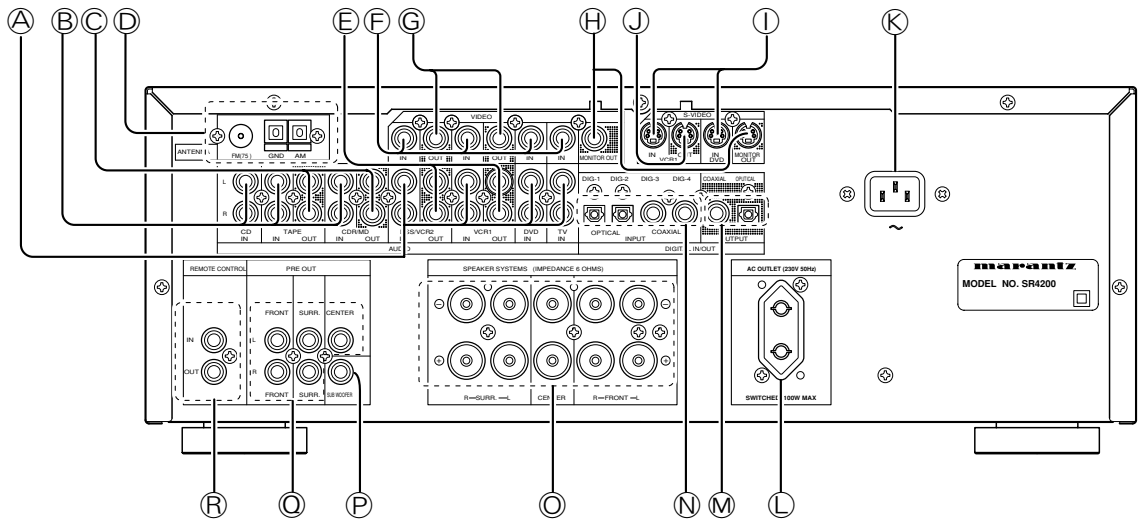

**VIDEO SYSTEM CONNECTIONS FOR VIDEO COMPONENTS**

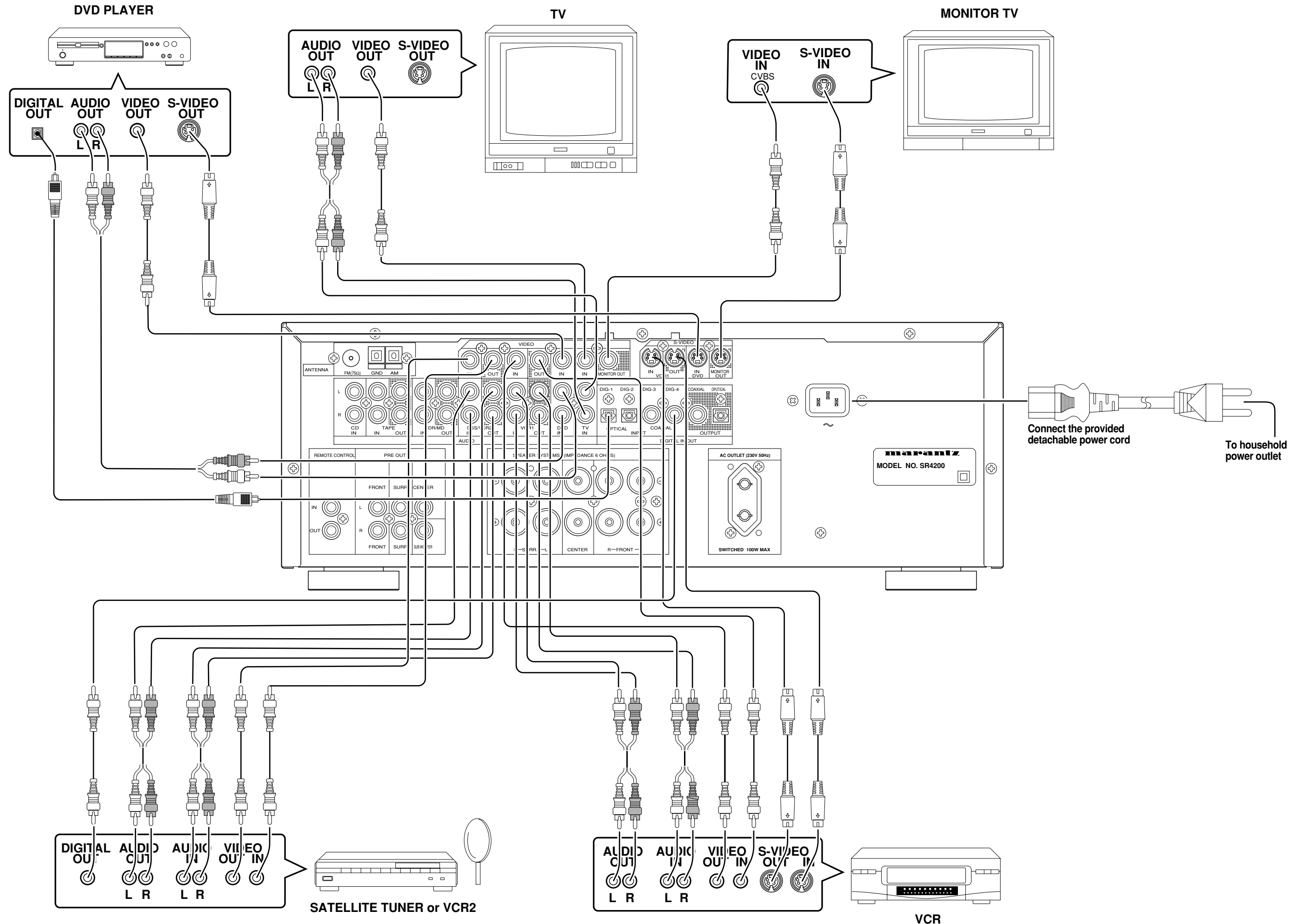

**AUDIO SYSTEM CONNECTIONS FOR AUDIO COMPONENTS**

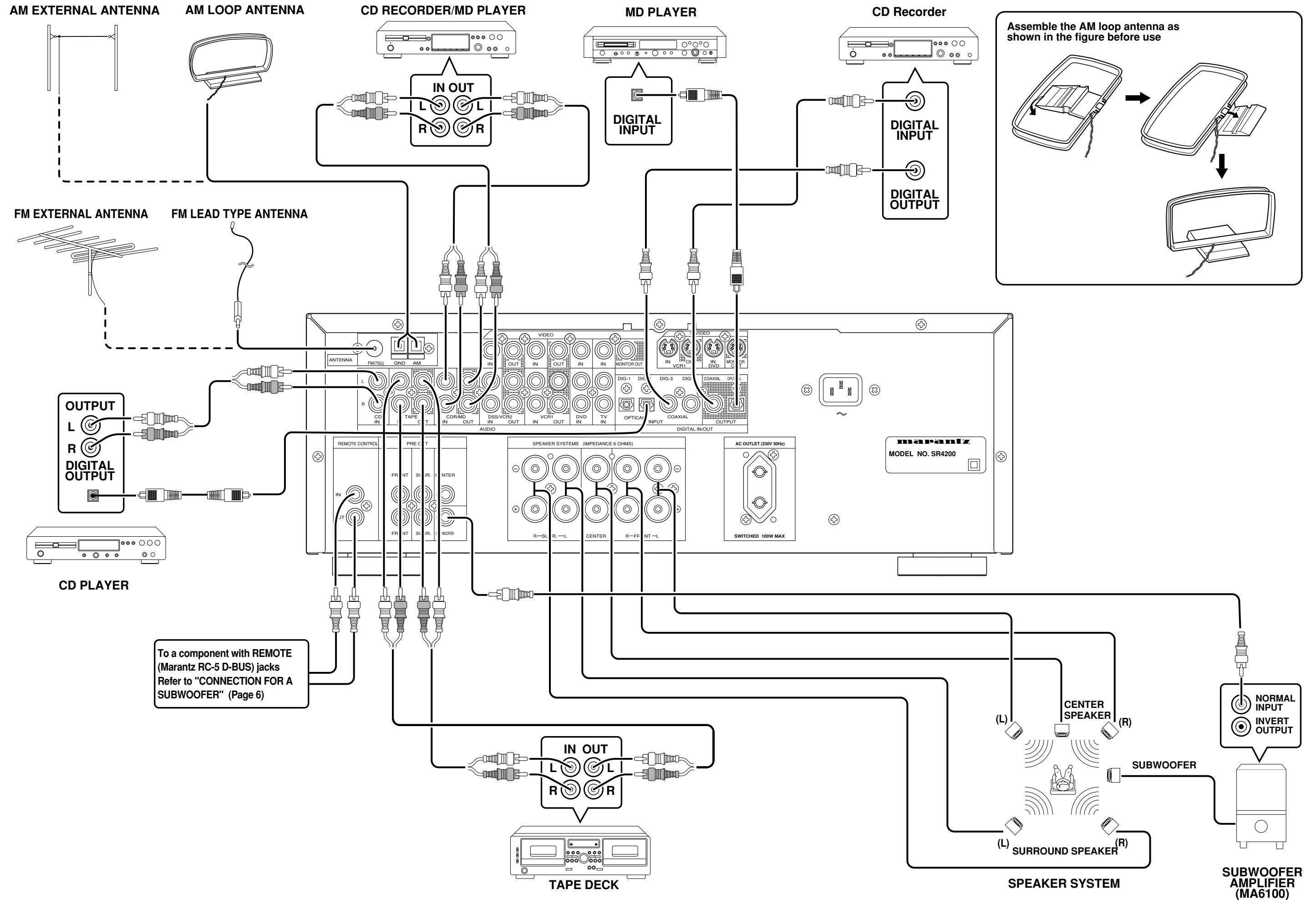

# TABLE OF CONTENTS

<b>FOREWORD</b> .....	<b>2</b>
<b>INTRODUCTION</b> .....	<b>3</b>
<b>DESCRIPTION</b> .....	<b>3</b>
<b>FEATURES</b> .....	<b>3</b>
<b>FRONT PANEL FEATURES</b> .....	<b>4</b>
<b>REAR PANEL CONNECTIONS</b> .....	<b>5</b>
<b>REMOTE CONTROL OPERATION</b> .....	<b>7</b>
OPERATION .....	7
FUNCTION AND OPERATION .....	7
PROGRAMMING THE REMOTE CONTROLLER .....	8
OPERATION OF REMOTE CONTROL UNIT .....	9
<b>SET-UP</b> .....	<b>10</b>
MENU FUNCTION .....	10
MENU STRUCTURE .....	10
SYSTEM SETUP .....	11
SPEAKERS SETUP .....	11
TEST MODE .....	12
<b>BASIC OPERATION</b> .....	<b>13</b>
LISTENING TO THE TUNER .....	13
RDS OPERATION .....	14
PLAYBACK OPERATION .....	15
SETTING THE SLEEP TIMER .....	15
<b>SURROUND MODES</b> .....	<b>16</b>
<b>TROUBLE SHOOTING</b> .....	<b>18</b>

## FOREWORD

This section must be read before any connection is made to the mains supply.

### WARNINGS

Do not expose the equipment to rain or moisture.  
Do not remove the cover from the equipment.  
Do not push anything inside the equipment through the ventilation holes.  
Do not handle the mains lead with wet hands.

### EQUIPMENT MAINS WORKING SETTING

Your Marantz product has been prepared to comply with the household power and safety requirements that exist in your area. SR4200 can be powered by 230 V AC only.

### IMPORTANT: (For UK version)

This apparatus is fitted with an approved moulded 13 Amp plug. To change a fuse in this type of plug proceed as follows:

1. Remove fuse cover and fuse.
2. Fix new fuse which should be a BS1362 13A, A.S.T.A. or BSI approved type.
3. Refit the fuse cover.

If the fitted plug is not suitable for your socket outlets, it should be cut off and an appropriate plug fitted in its place.

If the mains plug contains a fuse, this should have a value of 13A. If a plug without a fuse is used, the fuse at the distribution board should not be greater than 5A.

#### Note:

The severed plug must be destroyed to avoid a possible shock hazard should it be inserted into a 13A socket elsewhere.

### How to connect a plug

The wires in the mains lead are coloured in accordance with the following code:

BLUE—"NEUTRAL" ("N")

BROWN—"LIVE" ("L")

1. The BLUE wire must be connected to the terminal which is marked with the letter "N" or coloured BLACK.
2. The BROWN wire must be connected to the terminal which is marked with the letter "L" or coloured RED.
3. Do not connect either wires to the earth terminal in the plug which is marked by the letter "E" or by the safety earth symbol or coloured green or green-and-yellow.

Before replacing the plug cover, make certain that the cord grip is clamped over the sheath of the lead — not simply over the two wires.

### COPYRIGHT

Recording and playback of any material may require consent. For further information refer to the following:

- Copyright Act 1956
- Dramatic and Musical Performers Act 1958
- Performers Protection Acts 1963 and 1972
- any subsequent statutory enactments and orders

### ABOUT THIS USER GUIDE

Refer to the figures on page iii of this user guide. The numbers on the figures correspond to those in the text. All references to the connections and controls that are printed in **BOLD** type are as they appear on the unit.

## PRECAUTIONS

The following precautions should be taken when operating the equipment.

### GENERAL PRECAUTIONS

When siting the equipment ensure that:

- the ventilation holes are not covered;
- air is allowed to circulate freely around the equipment
- it is on a vibration free-surface;
- it will not be exposed to interference from an external source;
- it will not be exposed to excessive heat, cold, moisture or dust;
- it will not be exposed to direct sunlight;
- it will not be exposed to electrostatic discharges

Never place heavy objects on the equipment.

If a foreign body or water does enter the equipment, contact your nearest dealer or service centre.

Do not pull out the plug by pulling on the mains lead, hold the plug.

It is advisable when leaving the house, or during a thunderstorm, to disconnect the equipment from the mains supply.

### PRECAUTIONS IN CONNECTION

- Be sure to unplug the power cable from the AC outlet or turn off the POWER switch before proceeding with any connection.
- Connect one cable at a time observing the "input" and "output".  
This will avoid any cross connection between channels and signal inputs and outputs.
- Insert the plugs securely. Incomplete connection may result in noise.
- Prior to connecting other audio and video equipment to the SR4200, please read their owner's manuals.

### INSTALLATION

If this unit or another electronic device incorporating a microcomputer is used at the same time with the tuner or television, picture disturbance or noise may occur. In such a case, install the unit according to the following guide points.

- Separate the unit as far as possible from the television.
- Place the antenna wire for the tuner or TV apart from the power cable and audio and video connection cables of this unit.
- Since the phenomenon is likely to occur when using an indoor antenna and/or 300-ohm feeder wire, we recommend using an outdoor antenna and 75-ohm coaxial cable.



## INTRODUCTION

Thank you for purchasing the Marantz SR4200 DTS/Dolby Digital Surround receiver.

This remarkable component has been engineered to provide you with many years of home theater enjoyment.

Please take a few minutes to read this manual thoroughly before you connect and operate the SR4200.

As there are a number of connection and configurations options, you are encouraged to discuss your own particular home theater setup with your Marantz A/V specialist dealer.

## DESCRIPTION



DTS was introduced in 1994 to provide 5.1 channels of discrete digital audio into home theater systems.

DTS brings you premium quality, discrete multi-channel digital sound to both movies and music.

DTS is a multi-channel sound system designed to create full range digital sound reproduction.

The no compromise DTS digital process sets the standard of quality for cinema sound by delivering an exact copy of the studio master recordings to neighborhood and home theaters.

Now, every moviegoer can hear the sound exactly as the moviemaker intended.

DTS can be enjoyed in the home for either movies or music on DVD's, LD's and CD's.



Dolby Digital lets you enjoy Digital TV, Digital Satellite as well as DVD, LD software in digital surround, which is the next step above Dolby Pro Logic.

In Comparison with Dolby Pro Logic, Dolby Digital can provide separate left surround and right surround channels, for more precise localization of sound and a more convincing, realistic ambience.

And, with Dolby Digital all five main channels can be full ranged and a subwoofer can be added to each channel, if desired.

By providing up to 5.1 channels of digital audio independently. Dolby Digital lets you enjoy better sound quality and more powerful presence than conventional Dolby Surround.

Pro Logic II, the next generation in Dolby Surround Pro Logic technology, brings the excitement of surround sound to any existing stereo mix, while making existing Dolby Surround mixes sound more like discrete 5.1-channel surround sound. It works with CDs, VHS tapes and TV shows, and MP3 files and radio broadcasts-converting all of these source to surround sound, without the artifacts by other matrix-decoding technologies.

"Dolby", "Pro Logic", and the double-D symbol are trademarks of Dolby Laboratories. Confidential unpublished works.

"DTS" and "DTS Digital Surround" are registered trademarks of Digital Theater Systems, Inc.

## FEATURES

- Dolby Digital and DTS surround sound decoding, plus Dolby Pro Logic II decoding and a variety of additional surround modes.
- 96 kHz/ 24 bit decoding for highest possible fidelity and bandwidth, and high-resolution playback of 96 kHz/ 24 bit PCM audio sources.
- 70 watts to each of the five main channels; the power amp section features advanced, premium high-storage power supply capacitors, and fully discrete output stages housed in cast aluminum heat sinks.
- 5.1 channel pre-amp outputs for connection to external components such as a subwoofer and external power amplifiers.
- 2 Digital outputs for connection to CD-R or MD.
- High-quality AM (MW/LW) /FM tuner with 50 station presets.
- Source Direct switch bypasses, tone controls and bass management for purest sound quality.
- S-video and composite video switch.
- Radio Data System (RDS) provides information on FM broadcasts.

## FRONT PANEL FEATURES (SEE PAGE iii.)

### ① POWER switch and STANDBY indicator

Press the button to turn the power ON, and press again to turn it OFF. If the **POWER** switch is in the ON position, the power of this unit can be turned ON/OFF by pressing the **POWER** button on the remote control unit.

When this unit is in the standby mode with the **POWER** switch set to the ON position, pressing one of the **FUNCTION SELECTOR** buttons also allows to turn the power on.

The **STANDBY** indicator lights up when this unit is the standby mode (power OFF) by the remote control unit.

### ② PHONES jack for stereo headphones

Conventional dynamic headphones can be plugged in here.

#### Notes:

When using headphones, the surround mode is switched automatically to STEREO and the sound from the speakers is muted.

The surround mode returns to the previous setting as soon as the plug is removed from the jack.

### ③ SURROUND MODE Selector knob

When this knob is turned, the surround mode is switched in the following sequence.

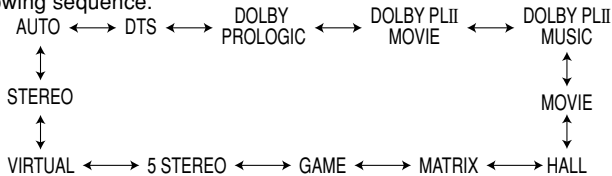

#### Note:

Not all modes will be present if an analog input is selected.

### ④ VOLUME control knob

Adjusts the overall sound level. Turning the control clockwise increases the sound level.

### ⑤ FUNCTION SELECTOR buttons (AUDIO/VIDEO)

These buttons are used to select the sources.

The video function selector, such as TV, DVD, VCR1 and DSS/VCR2, selects video and audio simultaneously.

### ⑥ A/D (Analog/Digital) SELECTOR button

This is used to select between the analog and/or digital inputs.

When analog input is selected, "ANALOG" will be shown in the display.

#### Note:

This button is not used for an input source that is not connected to a digital input.

### ⑦ S. ( Source) DIRECT button

When this button is pressed, the tone control circuit is bypassed as well as Bass Management.

#### Notes:

The surround mode is automatically switched to AUTO when the source direct function is turned on.

Additionally, Speaker Configurations are fixed automatically as follow.

Front speaker = Large

Center speaker = Large

Surround speaker = Large

Sub woofer = Yes

### ⑧ SLEEP button

Set the sleep timer function with this button.

### ⑨ DIMMER (Display off) button

When this button is pressed once, the display is dimmed.

When this button is pressed twice, the display is turned off and the "DISPLAY OFF" indicator lights up.

Press this button again to turn the display ON again.

### ⑩ MUTE button

Press this button to mute the output to the speakers. Press it again to return to the previous volume level.

### ⑪ CLEAR button

Press this button to cancel the station memory setting mode or preset scan tuning.

### ⑫ MEMORY button

Press this button to enter the tuner preset memory numbers and station names.

### ⑬ TUNING / PRESET UP and DOWN buttons

During reception of AM (MW/LW) or FM, you can scan the other frequencies or select another preset station pressing these buttons.

### ⑭ FREQUENCY / PRESET button

During reception of AM (MW/LW) or FM, you can change the function of the UP/DOWN buttons for scanning frequencies or selecting preset stations by pressing this button.

### ⑮ MODE button

Press this button to select the auto stereo mode or mono mode when the FM band is selected. The **M** indicator lights in the auto stereo mode.

### ⑯ INFRARED SENSOR window

This window receives infrared signals from the remote control unit.

## REAR PANEL CONNECTIONS (SEE PAGE iii.)

All connections to the rear panel should be made with the entire system powered off.

To avoid errors, it is advisable to connect one cable at a time between the various components.

### Ⓐ Analog audio inputs for video source equipment

**TV, DVD, VCR1, and DSS/VCR2**

Connect each input to the audio outputs of your video source equipment.

### Ⓑ Analog audio inputs

**CD, TAPE, and CD-R/MD**

Connect the audio outputs of your source components to the input jacks on the receiver.

### Ⓒ Analog audio outputs for audio source equipment

**TAPE and CD-R/MD**

Connect each output to the audio inputs (REC in) of your recording equipment.

### Ⓓ FM antenna terminal (75 ohms)

Connect an external FM antenna with a coaxial cable, or a cable network FM source.

#### AM antenna and ground terminals

Connect the supplied AM loop antenna. Use the terminals marked "AM" and "GND".

The supplied AM loop antenna will provide good AM reception in most areas.

Position the loop antenna until you hear the best reception.

### Ⓔ Analog audio outputs for video source equipment

**VCR1, and DSS/VCR2**

Connect each output to the audio inputs (REC in) of your video recording equipment.

### Ⓕ Video inputs

**TV, DVD, VCR1, and DSS/VCR2**

Connect each input to the video outputs of your video source equipment.

### Ⓖ Video outputs

**VCR1, and DSS/VCR2**

Connect each output to the video input (REC in) of your video recording equipment.

### Ⓗ TV MONI. (VIDEO/S-VIDEO) output jacks

Connect the TV MONI jack to your TV's video input (VIDEO IN) jack. You can connect your video equipment with S-VIDEO jacks if possible, or the composite VIDEO jacks.

**You must use the same type of connection from your video player into the receiver, and out of the receiver into your TV.**

Both must be composite video or both must be S-Video. You cannot convert a signal from one type to the other.

### Ⓙ S-video inputs

**DVD and VCR1**

Connect each input to the S-video outputs of your video source equipment.

### ⓵ S-video outputs

**VCR1**

Connect each output terminals to S-video input (REC in) of your video recording equipment.

### ⓶ AC INLET

Connect to supplied AC cable, and connect to AC power outlet. SR4200 can be powered by 230V AC only.

### ⓷ AC OUTLET

Connect the power cables of components such as a DVD or CD player to this outlet.

**Caution:**

In order to avoid potential turn-off thumps, anything plugged in here should be powered up BEFORE the SR4200 is turned on.

### ⓸ DIGITAL outputs

**Optical and Coaxial**

Connect digital input of your digital recording equipment.

### ⓹ DIGITAL inputs

**Fig.1, 2 (Optical) and Fig.3, 4 (Coaxial)**

Connect each input to the digital output of your equipment.

Use the system setup menu to assign digital input to appropriate source. (see page. 11)

**Note :**

Do not connect for LD player's RF out, If you want to decode this type of signal, an external demodulator must be used.

### ⓺ SPEAKER terminals

**FRONT Left & Right speakers output terminals**

Connect to the front left & right speakers.

**CENTER speaker output terminals**

Connect to the center speaker.

**SURROUND Left & Right speakers output terminals**

Connect to the surround (rear) left & right speakers.

### ⓻ SUB WOOFER output jack

Connect to the input jack(s) of the power amplifier for subwoofer channel or powered subwoofer.

### ⓼ PRE OUT jacks

Jacks for Front - L/R, Center and Surround.

Use these jacks for connection to an external power amplifier.

### ⓽ REMOTE CONT. IN/OUT terminals

Connect to a Marantz component equipped with remote control (RC-5) terminals.

**REMOTE CONTROL BUS CONNECTIONS**

This unit is equipped with a remote control function. By connecting this unit's remote control jacks to a Marantz CD player or tape deck equipped with remote control (RC-5) jacks, it allows system remote control to operate. Connect **RCREMOTE CONTROL OUT** jack of SR4200 to REMOTE CONTROL. IN of other Marantz equipment, i.e. CD player or tape deck, by using an RCA pin cable.

**Note:**  
If a component equipped with remote control (RC-5) jacks has an INT/EXT switch on the rear panel, set the switch to EXT when using the system control function with SR4200.

**(Connection example)**

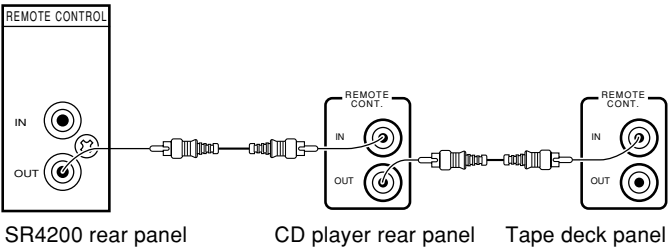

**CONNECTION FOR A SUBWOOFER**

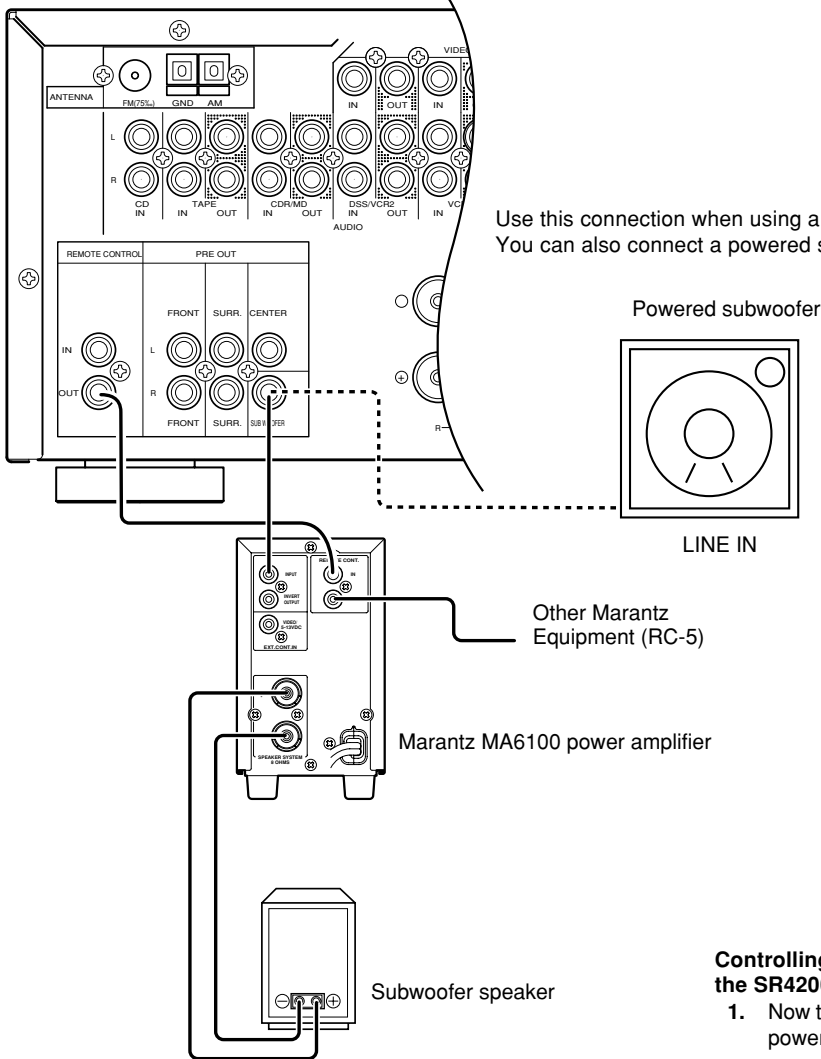

**Controlling the power ON/OFF of a power amplifier connected to the SR4200 through Marantz remote control**

1. Now the MA6100 can be turned ON / OFF in synchronism with the power ON / OFF of the SR4200.

**Notes:**

- Be sure to connect the remote control bus before the procedure above.

# REMOTE CONTROL OPERATION

## OPERATION

The provided remote control unit is a universal remote controller. The **POWER** button [2], numeric buttons [9] and control buttons [12] are used in common across different input source components.

The input source controlled with the remote control unit changes when one of the input selector buttons [3] is pressed.

• Example: To select the DVD as the input source and play the DVD player.

Press the **DVD** button [3] twice within 2 seconds.

The input selector of the SR4200 is switched to DVD and the remote control unit is set for control of the DVD player. Press the **PLAY** button on the remote controller .

## FUNCTION AND OPERATION

### 1 Transmitting indicator

Lights up during a button is pressed and an infrared signal is sending.

### 2 Main POWER buttons

Press to switch the power of the SR4200 ON or OFF after pressing the **AMP** button [3].

### 3 Input selector buttons/ FUNCTION SELECTOR buttons (AUDIO/VIDEO INPUT)

Press one of these buttons once or twice to select a particular source component. For example, to set the receiver to the DVD input, press the **DVD** button twice within 2 seconds.

**Note:**

**CDR/MD** button is set CDR function at initial. To switch MD function, press and hold down **CDR/MD** button and press **2** button [9].

To return CDR function, press and hold down **CDR/MD** button and press **1** button [9].

### 4 MAIN VOLUME UP (▲) /DOWN (▼) buttons

Main volume control of the SR4200. The front, surround, center and subwoofer channel volumes controlled by these buttons simultaneously.

### 5 MUTE button

Muting button of the SR4200. Press this button decrease the sound temporarily . Press this button again to return to the previous sound.

### 6 MENU button

This button is used to enter the menu functions. Use the menu functions to setup SR4200.

### 7 Cursor buttons (◀, ▶, ▲, ▼, OK)

Use these button when operating the menu functions. See page 10.

### 8 MENU OFF button

This button is used to return original display from menu functions.

### 9 Numeric buttons 1 to 9 (A, B, C ... Z, -) / Surround mode buttons

#### Numeric buttons

These buttons are used to enter figures in the selection of a tuner preset station and station name preset or to set select a CD track number, etc. The functions of these buttons are dependent on the function button selected.

#### Surround mode buttons (when AMP mode is selected)

These buttons are used to select the surround mode.

**Note:**

The **6-STEREO** button is used to 5-stereo mode for SR4200.

The **CS5.1** and **6.1** buttons are unavailable for SR4200.

### 10 P.SCAN (preset scan) button (when TUNER mode is selected)

When this button is pressed, SR4200 is turned to tuner (last memory) and preset scan starts.

### 11 0 / A/D button

#### 0 button

This button is used to enter the number "0"

#### A/D button (when AMP mode is selected)

This is used to switch between the analog and digital inputs.

### 12 CONTROL buttons

These buttons are used when operating the CD player, TAPE deck, etc. The function of these buttons are dependent on the function button selected.

For the controllable functions of each input function, please refer to following table.

	TV	VCR	DVD	DSS	TUNER	CD	TAPE	CDR	MD
◀ CHANNEL/SKIP	CH-	PREV	PREV	CH-	CH-	PREV	PREV	PREV	PREV
▶ CHANNEL/SKIP	CH+	NEXT	NEXT	CH+	CH+	NEXT	NEXT	NEXT	NEXT
◀ TUNE/SEARCH	---	REWIND	REWIND	---	TUNING-	REWIND	REWIND	REWIND	REWIND
▶ TUNE/SEARCH	---	FF	FF	---	TUNING+	FF	FF	FF	FF
●	---	REC	---	---	---	---	REC	REC	REC
◀▶ MODE	---	---	---	---	MODE	---	DIRECTION	---	---
DSIP/RDS	CH DISPLAY	PAUSE	PAUSE	CH DISPLAY	RDS DISPLAY	PAUSE	PAUSE	PAUSE	PAUSE
▶ F.DIRECT	---	PLAY	PLAY	---	FREQ. DIRECT	PLAY	PLAY	PLAY	PLAY
+A/ANT	VIDEO	TV/VCR	DISC +	DSS/VCR	---	DISC +	DECK A	---	---
-B/VCR	VIDEO	TV/VCR	DISC +	DSS/VCR	---	DISC -	DECK B	---	---
■ PTY	---	STOP	STOP	---	RDS PTY	STOP	STOP	STOP	STOP

### 13 ATT (attenuater) button

When the input signal is too high and the voice distorts even by throttling the SR4200 VOLUME control and PEAK indicator will light up, turn on this function. "ATT" is indicated when this function is activated

The input level is reduced. Attenuater is invalid for use with the output signal of "REC OUT".

### 14 TREBLE buttons

These buttons are used to adjust the tone control of high frequency sound for left, center and right speaker.

### 15 BASS buttons

These buttons are used to adjust the tone control of low frequency sound for left, center right and subwoofer speaker.

### 16 MEMO button

Memory enable button for various preset functions.

**17 CLEAR button**

This button is used to cancel for certain memory or programming operations.

**18 DIMMER button**

When this button is pressed once, the display is dimmed.

When this button is pressed twice, the display is turned off and the "DISPLAY OFF" indicator lights up.

Press this button again to turn on the display again.

**19 NIGHT button**

Pressing this button prevents the Dolby Digital signal from playback at a loud voice. This function reduces the voice by 1/3 to 1/4 at maximum. Thus, it eliminates the occurrence of an abruptly loud voice at night. However, the function is valid only for the case when the Dolby Digital signal is entered into OPTICAL or COAXIAL and data to compress the voice exists in the signal to be played back.

**20 S- ( Source) DIRECT button**

When this button is pressed, the tone control circuit is bypassed as well as Bass Management.

**21 SETUP / T.TONE button**

Test tone function is used for adjusting the balance between the volume levels of speaker channels. Press AMP button and press this button to generate pink noise from each channel. Press the button again to stop the pink noise generation.

**22 OSD button**

This button is not used for SR4200.

**23 SLEEP (sleep timer) button**

This button is used for setting the sleep timer. It can be operated the same way as the button in unit.

**24 TV VOLUME UP (▲) /DOWN (▼) buttons**

These buttons increase or decrease TV's volume.

**PROGRAMMING THE REMOTE CONTROLLER**

The remote controller RC5200SR must be programmed to use the codes for your appliances of different brands. This is done by keying in a 4-digit code or by scanning the codes until the correct one is found. We recommend to using the 4-digit code. This mode is faster and more reliable. The code scanning method should be used only if you cannot find the code for one of your appliances. The codes are listed at the end of this book.

**Important:**

Use the remote control buttons for programming, not the buttons of the receiver or other appliances.

**PROGRAMMING WITH THE 4-DIGIT CODE**

1. Press and hold down the function button [3] for the appliance which should be controlled and press **SETUP** [21] until the indicator [1] blinks twice.
2. Press the 4-digit code for appliance (codetable at the end of this book)
3. When the procedure is successful, the indicator will blink twice.

**Notes:**

If the indicator did not blink twice, then repeat steps 1 through 2 and try entering the same code again.

**SCANNING THE CODE TABLE**

1. Switch on the appliance which should be controlled.
2. Press and hold down the function button [3] for appliance which should be controlled and press **SETUP** [21] until the indicator [1] blinking twice.
3. Press the code **9 - 9 - 1**.  
The indicator will blink twice.
4. Aim the remote control at the appliance and slowly alternate between pressing **POWER** [2] and the function button [3] for the appliance.
5. Stop when the appliance turns off.
6. Press **SETUP** [21] once to lock in the code.

**CHECKING THE CODE**

1. Press and hold down the function button [3] for appliance which should be controlled and press **SETUP** [21] until the indicator [1] blinking twice.
2. Press the code **9 - 9 - 0**.  
The indicator will blink twice.
3. To view the code for first digit, press **1** once.  
Wait 3 seconds, count the indicator blinks (e.g. 3 blinks = 3) and write down the number.  
**Note:**  
If a code digit is "0", the indicator will not blink.
4. Repeat step 3 three more times for remaining digits. Use **2** for the second digit, **3** for the third digit, and **4** for the fourth digit.

Once you have found and the codes for your various appliances, you may want to write them down here.

- TV \_\_\_\_\_
- VCR \_\_\_\_\_
- DSS \_\_\_\_\_
- DVD \_\_\_\_\_
- CD \_\_\_\_\_
- TAPE \_\_\_\_\_
- CDR \_\_\_\_\_
- MD \_\_\_\_\_

## OPERATION OF REMOTE CONTROL UNIT

### 1. Remote control

The distance between the transmitter of the remote control unit and the IR SENSOR of the SR4200 should be less than about 5 meters. If the transmitter is pointed to a direction other than the IR SENSOR or if there is an obstacle between them, remote control may not be possible.

#### Remote-controllable range

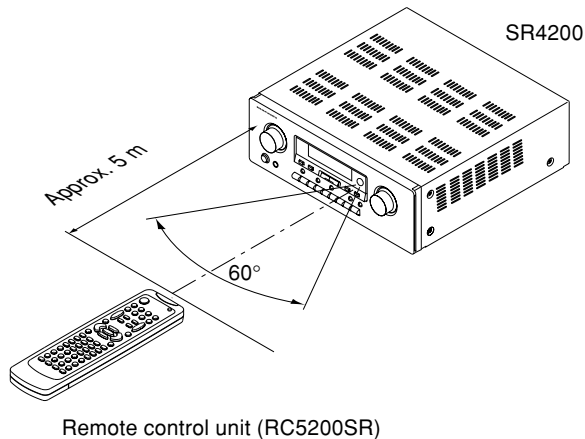

### 2. Loading batteries

The life of the batteries used with the remote control unit is about 4 months with normal use. Also be sure to replace batteries earlier when you notice that they are getting weak.

(1) Remove the back cover.

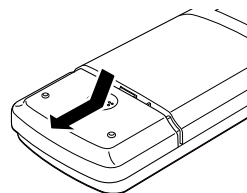

(2) Insert the new batteries (AAA type) with correct (+) and (-) polarity.

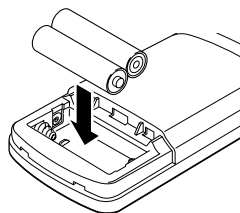

(3) Close until it clicks.

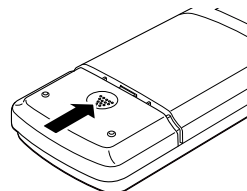

# SET-UP

After all components are connected, initial setup must be performed.

## MENU FUNCTION

The SR4200 incorporates a menu function, which makes various operations possible by using the cursor (◀, ▶, ▲, ▼) and OK buttons on the remote controller.

## MENU STRUCTURE

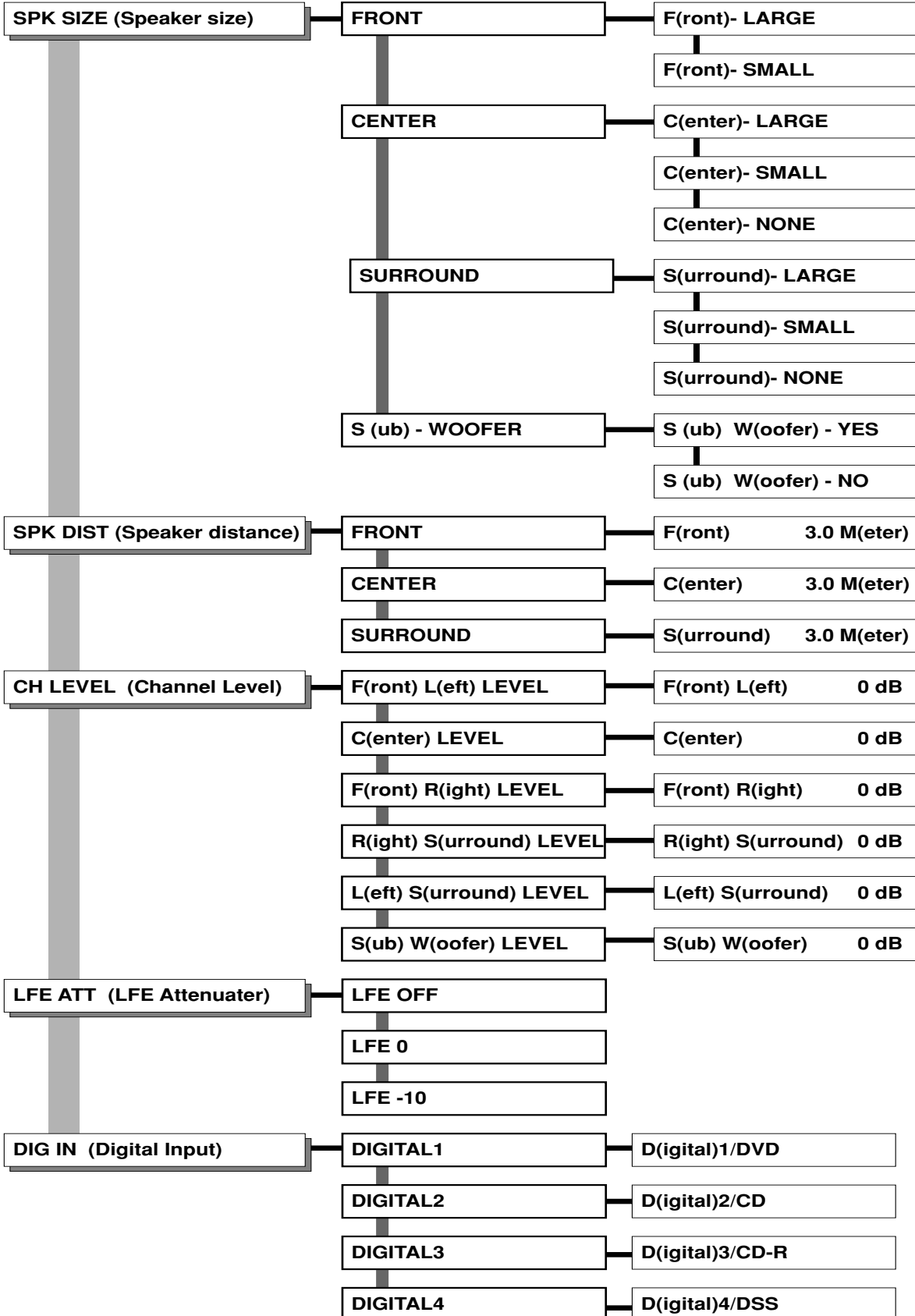



## SYSTEM SETUP

1. Press the **AMP** button [3].
2. Press **MENU** button [6] display the menu.



Choose a desired item in the contents with ▲ or ▼ button, and press the **OK** or ► button to select. Display will change to menu for each item.

**Note:**

If no operating continues for 1 minute or more, the setup menu is cancelled and the display will return to original.

## SPEAKERS SETUP

The home theater system you already have installed should function provided that there are left, center and right front speakers, left and right rear/surround speakers and a subwoofer. For best results we recommend that all front speakers be of the same type, with identical or similar driver units. This will deliver smooth pans across the front sound stage as the action moves from side to side. Your center channel speaker is very important as over 80 % of the dialog from a typical motion picture emanates from the center channel. It should possess similar sonic characteristics to the main speakers. Rear channel speakers need not be identical to the front channel speakers, but they should be of high quality. One of the benefits of both Dolby Digital (AC-3) and DTS is that surround channels are discrete full range, while they were frequency limited in earlier "Pro Logic" type systems. Bass effects are an important part of home theater. For optimal enjoyment a subwoofer should be used as it is optimized for low frequency reproduction. If you have full range front speakers, however, they may be used in place of a subwoofer with proper setting of the switches in the menu system.

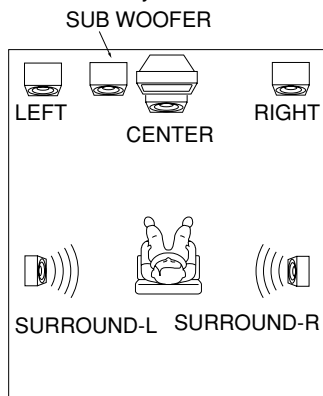

If possible, mount the surround speakers on the walls to the sides of the viewing area, 2-3 feet above seated viewers, firing straight across at each other.

### SPK SIZE (Speake size)

This menu enters the information about which type of speakers will be used for each channel. In turn, these settings will determine which speakers receive low frequency information. For the purpose of establishing proper bass reproduction, use the LARGE settings if the speaker being used at any position is a traditional full-range loudspeaker that is capable of reproducing sound below 100 Hz and you are not using a subwoofer. Use the SMALL setting for smaller, frequency-limited speakers that are not able to reproduce sounds below 100Hz and you are using a subwoofer. Low frequencies will be diverted from the speaker to the subwoofer. Note that when "small" speakers are used it is advisable to install a separate subwoofer, especially if you wish to appreciate the full impact of a good home theater soundtrack. If the Surround speakers or Center speaker will not be used, set NONE for each speaker. The NONE setting will send the audio for the surround channels or Center channel to the front left/right speakers.

**FRONT :** Select the type of front speakers with ▲ or ▼ button.



**CENTER :** Select the type of center speaker with ▲ or ▼ button.



**SURROUND:** Select the type of surround speakers with ▲ or ▼ button.



**S-WOOFER:** Select the subwoofer speaker YES or NO with ▲ or ▼ button.



**Notes:**

This speaker size setup is not effective when the SOURCE-DIRECT is selected. When the front speakers are set to SMALL, the setting for subwoofer is automatically set to YES. This subwoofer setting will not be shown on the display.

### SPK DIST (Speaker distance)

Use this parameter to specify the distance of the speaker's position from the listener. The delay time is automatically set according to these distances.

**UNITS:**Select speaker with ▲ or ▼ button, and input each speaker's distance with ▲ or ▼ button. When the input for each speaker's distance has been finished, and press the **OK** or ► button.

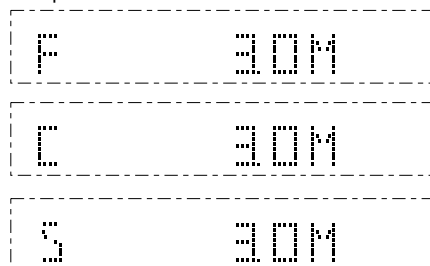

**Notes :**

Placement beyond that distance is beyond the range of the automatic time delay feature. The delay feature does not function in the SOURCE-DIRECT and decoding of 96 kHz sources.

### CH LEVEL (Channel level)

Desired channels can be selected by pressing ▲ or ▼ button. Each channel level will be adjusted by pressing ▲ or ▼ button. Only the usable channels which are determined depending on the SURROUND mode, and SPEAKER SETTING are displayed.

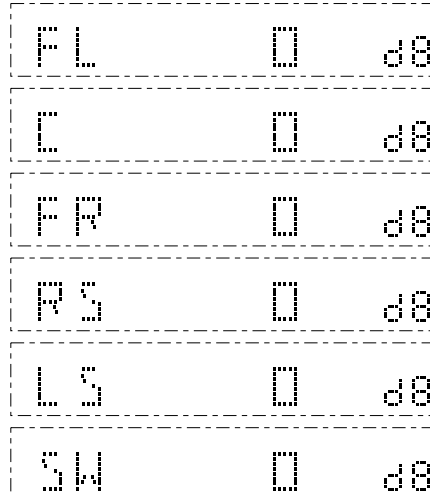

**LFE ATT (LFE attenuater)**

Select the output level of the LFE signal included in the Dolby Digital signal or the DTS signal. Select 0dB, -10 dB or OFF with ▲ or ▼ button.

The level is ordinarily set to 0 dB. When use DTS Music source, LFE level is set to -10 dB.

**DIG IN (Digital input)**

Four digital inputs can be assigned for the desired source. Use this menu to determine which source is connected to which input.

**Example;**

When the digital output of a DVD player is connected to Digital 4 (input jack) of the SR4200;

1. Select "DIG IN" with cursor buttons ▲ or ▼ and press the OK or ► button.



2. Select "DIGITAL4" with cursor buttons ▲ or ▼ and press the OK or ► button.



3. Select "D4/DVD" with cursor buttons ▲ or ▼ and press the OK or ► button.



4. If you desire to continue the next setup, press the OK or ► button on NEXT-SETUP.  
If you desire to exit from menu system, press the MENU OFF button on EXIT.

**Notes:**

The TUNER is assigned to the analog input, and are prevented from selecting any digital input.

While the DTS-LD or DTS-CD is playing, this setup is not available, this is to avoid noise being generated from the analog input. Stop the LD or CD playback to setup.

The SR4200 does not switch from digital input to analog input or vice versa automatically.

In the event that both digital and analog inputs are connected to SR4200, if you desire to switch to an analog input temporarily, you can switch by pressing the A/D button ⑥.

**TEST MODE**

When you press the T.TONE ⑫, the test tone will be cycled through in a circular pattern which is FL (front left) → C (center) → FR (front right) → RS (right surround) → LS (left surround) → SW (subwoofer) → FL → ... 3 seconds for each channel.

# BASIC OPERATION

## LISTENING TO THE TUNER

### MANUAL TUNING

1. To select the tuner as the source, press the **TUNER** button ⑤ on the front panel or press the **TUNER** button ③ on the remote.
2. Press the **TUNER** button ⑤ on the front panel or press the **TUNER** button ③ on the remote to select the desired frequency band if required.
3. Press the **F/P** button ⑭ on the front panel to display the frequency.
4. Press the **TUNING/PRESET ▲** or **▼** button ⑬ on the front panel or press the **◀◀** or **▶▶** button ⑫ on the remote.
5. If FM is selected, press the **MODE** button ⑮ on the front panel or press the **MODE** button ⑫ on the remote control to select the desired audio mode.

### (FM) MODE BUTTON OPERATION

When "M" indicator is on in the display, FM stations that broadcast in stereo will be received in stereo and the "STEREO" indicator lights. When "M" indicator is off, all the FM stations will be received in mono regardless of whether or not they are broadcasting in stereo.

### AUTO TUNING (USING THE SR4200)

1. Press the **F/P** button ⑭ on the front panel to display the frequency.
2. Press the **TUNING/PRESET ▲** or **▼** button ⑬ on the front panel for more than 1 second to start the Auto tuning function.

### AUTO TUNING (USING THE REMOTE CONTROL UNIT)

Press **◀◀** or **▶▶** button ⑫ for more than 1 second to start the Auto tuning function.

### PRESET TUNING

With this unit you can preset up to 50 FM/AM (MW/LW) stations in any order. For each station, you can memorize the frequency and reception mode if desired.

#### 1-a. Manual Presetting (Using the SR4200)

1. Refer to the "MANUAL TUNING" or "AUTO TUNING" section above to tune in a desired station.
2. Press the **MEMORY** button ⑫. "MEMO" indicator starts blinking on the display.  
While "MEMO" is still blinking (approx. 5 seconds), select the preset number by pressing the **TUNING/PRESET ▲** or **▼** button ⑬ then press the **MEMORY** button ⑫ again.
3. When a number has been properly input, "MEMO" indicator stops blinking and goes out.  
The station is now stored in the specified preset memory location.

#### 1-b. Manual Presetting (Using the remote control unit)

1. Tune in a desired station.
2. Press the **MEMO** button ⑫.
3. Enter the desired preset number with ten keypad ⑨.  
\* When entering a single digit number (2, for example), either input "02" or just input "2" and wait for a few seconds.  
\* If a number other than 1-50 is entered by mistake, that number flashes in the display to indicate that it is invalid and the display returns to the original frequency display.

#### 2. Auto Presetting

This function automatically scans the AM (MW/LW) and FM band and enters all stations with sufficient signal strength into the memory.

1. Select the FM band with the **TUNER** button ⑤.
2. Tune in the lowest receivable frequency.
3. Press and hold down the **MEMORY** button ⑫ and **TUNING/PRESET ▲** button ⑬ simultaneously, auto presetting will start.
4. Each time the tuner finds a station, the scanning will pause and memory.
5. Operation stops automatically when all 50 preset memory positions are filled or when auto scanning attains the highest end of all bands.  
To stop the auto preset function at anytime, press the **CLEAR** button ⑪.

#### 3. Recalling a Preset Station

1. Press the **F/P** button ⑭ to change the display to preset.
2. Select the desired preset station by pressing **TUNING/PRESET ▲** or **▼** button ⑬ on the front panel or press **CHANNEL** button ⑫ on the remote.

#### Note:

To directly access the preset stations using the numeric keypad, select the desired preset station by entering one or two digits using the numeric keypad ⑨.  
To return to the Manual Tuning mode, press the **F/P** button ⑭.

#### 4. Preset Scan Tuning (Using the remote control unit)

1. Press the **P.SCAN** button ⑩ on the remote control. (The preset station with the smallest preset number is recalled first. If no stations have been preset, CH "00" blinks in the display and the unit returns to the previous mode.)
2. Preset stations are recalled in sequence (CH-1 → CH-2, etc.) for 5 seconds each. Preset numbers that do not contain stations are skipped.
3. You can fast forward the preset stations by pressing the **CHANNEL ▶▶** button ⑫ continuously.  
When the desired preset station is received, cancel the preset scan operation by pressing the **CHANNEL ◀◀** button ⑫ or the **CLEAR** button ⑪.

#### 5. Clearing Preset Stations

You can remove preset stations from memory using the following procedure.

1. Recall the preset number to be cleared with the method described in "Recalling" a preset station .
2. Press the **MEMORY** button ⑫ on the front panel or **MEMO** button ⑫ on the remote unit, "MEMO" blinks in the display for 5 seconds. While "MEMO" is still blinking, press the **CLEAR** button ⑪ on the front panel or **CLEAR** button ⑪ on the remote unit.  
"CLEAR" appears on the display to indicate that the specified preset number has been cleared.

## STATION NAME PRESET

The station name preset function allows the name of each preset channel to be entered using alphanumeric characters. The Station Name button is valid only in the tuner mode. Before station name preset operation, store stations with the preset memory operation.

1. Press the **MEMORY** button  $\text{\textcircled{12}}$  on the front panel or **MEMO** button  $\text{\textcircled{16}}$  on the remote for more than 3 seconds.
2. The left most column of the station name indicator flashes, indicating the character entry ready status.

### [Operation (Using the SR4200)]

3. When you press the **TUNING/PRESET**  $\blacktriangle$  or  $\blacktriangledown$  buttons  $\text{\textcircled{13}}$  is turned, alphabetic and numeric characters will be displayed in the following order:  
**A**  $\rightarrow$  **B**  $\rightarrow$  **C** ... **Z**  $\rightarrow$  **1**  $\rightarrow$  **2**  $\rightarrow$  **3**.... **0**  $\rightarrow$  -  $\rightarrow$  +  $\rightarrow$  /  $\rightarrow$  (**Blank**)  $\rightarrow$  **A**  
 UP  $\rightarrow$   
 $\leftarrow$  DOWN
4. After selecting the first character to be entered, press the **MEMORY** button  $\text{\textcircled{12}}$ . The entry in this column is fixed and the next column starts to flash. Fill the next column and press the **MEMORY** button  $\text{\textcircled{12}}$  for more than 3 seconds to confirm the entry.

### [Operation (Using the remote control unit)]

First, press the **TUNER** button  $\text{\textcircled{3}}$  on the remote control unit.

(This operation is not necessary if the remote control unit has already been operated in the TUNER mode.)

3. Enter the character using the ten keypad  $\text{\textcircled{9}}$ . For example, to enter "A":  
 1) Press the "1" button. "A" appears on the display column.  
 2) Every time the 1 button is pressed, the displayed character changes in the order: **A**  $\rightarrow$  **B**  $\rightarrow$  **C**  $\rightarrow$  **1**  $\rightarrow$  **A**...  
 Pressing buttons other than the "1" button cause different characters to be displayed in a similar way, so that other alphanumeric characters can be entered. To enter a blank or space, press the "9" button.
4. When the desired character is displayed, press the **MEMO** button  $\text{\textcircled{16}}$  to confirm the entry in this column and move to the next column. After having filled all of the 8 columns, press the **MEMO** button  $\text{\textcircled{16}}$ , for more than 3 seconds to confirm the entry.

## FREQUENCY DIRECT CALL (Using the remote control unit)

1. Press the **F.DIRECT** button  $\text{\textcircled{12}}$  in the TUNER MODE on the remote controller.
2. Front display will show "F-DIR IN".
3. Input your desired frequency with ten key pad button on the remote.

## RDS OPERATION

Now in use in many countries, RDS (Radio Data System) is a description of the station's programming hidden space in the FM signal.

Your new receiver is equipped with RDS to assist in the selection of FM stations using station and network names, rather than broadcast frequencies. Additional RDS functions include the ability to search for programme types.

### RADIO TEXT

Some RDS stations broadcast RADIO TEXT, which is additional information on the station and programme being broadcast.

RADIO TEXT information appears as 'running' text in the display. RADIO TEXT is transmitted character-by-character by the radio station. As a result of that it may take some time until the entire text has been completely received.

### RDS DISPLAY

When a receiver is tuned to an FM station that is transmitting RDS data, the Front Panel Information Display will automatically show the station name or RDS TEXT in place of the typical display of the station's broadcast frequency.

To change the display, press the **RDS** button  $\text{\textcircled{12}}$  on the remote controller.

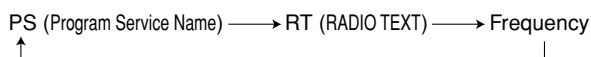

### PROGRAMME TYPE (PTY) DISPLAY

The RDS system categorizes programmes according to their genre into different programme type (PTY) groups. To display the programme type information of the current station, press the **PTY** button  $\text{\textcircled{12}}$  in the TUNER MODE on the remote controller.

### PTY AUTO SEARCH

Your receiver is equipped to automatically search for stations transmitting any of 29 different programme types. To search for a PTY, follow these procedures:

1. Press the **PTY** button  $\text{\textcircled{12}}$  in the TUNER MODE on the remote controller. The current station's PTY will be displayed, or the currently selected PTY group will be displayed in blinking if no station or RDS data is present.
2. To change to a new PTY type, press the **CHANNEL** button  $\text{\textcircled{12}}$  until the desired PTY is shown in the display.
3. Once the desired PTY group or type has been selected, press the **PTY** button  $\text{\textcircled{12}}$  while the display blink (approx. 5 seconds). The PTY Auto search will start, and the tuner will pause at each station broadcasting RDS PTY information corresponding to the selected choice.
4. To advance to the next RDS station with the desired PTY, press the **PTY** button  $\text{\textcircled{12}}$  again within 5 seconds.

NUMBER	DISPLAY	PROGRAMME TYPE
1	POP	Pop Music
2	ROCK	Rock Music
3	MOR	M. O. R. Music
4	LIGHT	Light classical
5	CLASSIC	Serious classical
6	NEWS	News
7	AFFAIR	Current Affairs
8	INFO	Information
9	SPORT	Sport
10	EDUCATE	Education
11	DRAMA	Drama
12	CULTURE	Culture
13	SCIENCE	Science
14	OTHERS	Varied
15	OTHER	Other Music
16	WEATHER	Weather
17	FINANCE	Finance
18	CHILDREN	Children's programmes
19	SOCIAL	Social Affairs
20	RELIGION	Religion
21	PHONE IN	Phone In
22	TRAVEL	Travel
23	HOBBIES	Hobbies
24	JAZZ	Jazz Music
25	COUNTRY	Country Music
26	NATION	National Music
27	OLDIES	Oldies Music
28	FOLK	Folk Music
29	DOCUMENT	Documentary

## PLAYBACK OPERATION

### NORMAL PLAYBACK

1. Press the **POWER** button ① / 2.
2. Press the **FUNCTION SELECTOR** button ⑤ on the front panel or press the **FUNCTION** button ③ on the remote unit to select an input source.

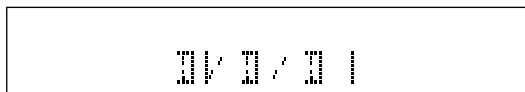

3. Turn the **SURROUND MODE SELECTOR** knob ③ on the front panel or Surround mode buttons ⑨ in the AMP MODE on the remote unit to select the desired surround mode.



4. Adjust the volume level using the **VOLUME** knob ④ on the front panel or press the **MAIN VOL.** button ④ on the remote. If necessary, adjust the tone, press the **TRB▲**, **TRB▼** ⑭ and **BAS▲**, **BAS▼** ⑮ on the remote unit.

### Note:

In case of remote control operation, press one of the function buttons twice within 2 seconds to select the function.

## SETTING THE SLEEP TIMER

Set the sleep timer while the power is turned on.

1. Turn the power ON and press the **SLEEP** button ⑧ / 23.
2. Press the **SLEEP** button ⑧ / 23 the number of times to set the desired sleep time in minutes.

Each press of the **SLEEP** button ⑧ / 23 or changes the display in the following order:

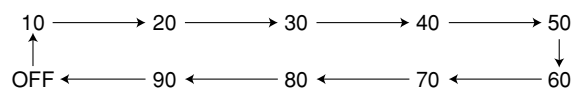

The unit will shut off in the number of minutes indicated.

\* While the sleep timer is activated, the remaining time can be displayed for approximately 2 seconds by pressing the **SLEEP** button ⑧ / 23.

\* To cancel the sleep timer, press the **SLEEP** button ⑧ / 23 and then press the **CLEAR** button ① / 17.

## SURROUND MODES

The SR4200 incorporates digital signal processors (DSP) which can reproduce various surround effects you experience in concert halls and movie theaters, etc. These Surround Modes, are provided to reproduce a variety of surround sound effects, according to the content of the source to be played.

Surround mode	FEATURES
1. <b>AUTO</b>	When this mode is selected, the receiver determines whether the digital input signal is Dolby Digital, PCM-audio or DTS. <b>Note:</b> When a Dolby Digital or DTS signal is input, the number of channels for which the corresponding signal is encoded will be played. Inputting a Dolby Digital two channel signal with Dolby surround status automatically subjects that signal to ProLogicII processing before play. 96 kHz source material can be playback in this mode and 96k will be shown in the display.
2. <b>STEREO</b>	This mode bypasses all surround processing. Stereo program sources the left and right channels play normaly when PCM-audio or analog stereo is input. With Dolby Digital and DTS sources, the 5.1 multi-channels are converted to two channel stereo. 96 kHz source material can be playback in this mode and 96k will be shown in the display.
3. <b>□□</b>	This mode is used with source materials encoded in Dolby Digital and Dolby Surround. Dolby Pro Logic II brings the excitement of surround sound to any stereo mix, while making existing Dolby Surround mixes sound more like discrete 5.1 channels Surround sound. Dolby Pro Logic II has below 3 modes.
<b>MOVIE</b>	This mode provides 5.1 channel surround sound from Dolby Surround encoded stereo movie sound tracks.
<b>MUSIC</b>	This mode provides 5.1 channel surround sound from conventional stereo sources, analog or digital, such as CD, tape, FM, TV, stereo VCR, etc.
<b>PRO LOGIC</b>	This mode emulated original Dolby Pro Logic decoding (3/1 surround) suit for Dolby Surround encoded stereo movie soundtracks. <b>Note:</b> PCM-audio signals can be subjected to Pro Logic processing when the sampling frequency is 32 kHz, 44.1 kHz or 48 kHz. When a signal in another format is input, output will be muted.
4. <b>DTS</b>	This mode is for DTS encoded source materials such as LASER DISC, CD, and DVD. The DTS mode cannot be used when an Analog input has been selected. When the signal in another digital format is input, output will be muted.
5. <b>MOVIE HALL MATRIX GAME</b>	These modes provide surround effect processing from each input source material. They will produce theater, concert hall and stadium like atmospheres. Select as your taste desires. <b>Note:</b> PCM-audio (32 kHz, 44.1 kHz or 48 kHz) and analog source material can playback in this mode.
6. <b>VIRTUAL</b>	This mode create the virtual surround sound with the front right and left speakers. <b>Note:</b> PCM-audio (32 kHz, 44.1 kHz or 48 kHz) and analog source material can playback in this mode.
7. <b>5-STEREO</b>	This mode is used to create a wider, deeper and more natural soundstage from two channel source material. This is done by feeding the left channel signal to both left front and left surround speaker and the right channel signal to both right front and right surround speaker. Additionally, the center channel reproduces a mix of the right and left channel. <b>Note:</b> The 96 kHz sampling frequency mutes output.

### Caution for DTS signal:

This signal can be played when the connected DVD-player, laser-disc player or CD-player is capable of DTS-digital output. For details, refer to the player's operation manual.

Depending on the player used, DTS play may produce noise. If that happens, set the Surround mode to DTS.

Playing a DTS-CD or DTS laser disc causes the player's analog output terminal to output noise. Before playing DTS sources, be sure to connect the player's digital output to the SR4200's digital input. Be careful when connecting the output of these players to analog audio input.

Note that the SR4200 has the following restrictive functions built in to reduce noise emission as much as possible.

If DTS is selected while in the Surround mode, digital input cannot be switched to analog input. When the analog input function has been selected, Surround mode cannot be switched to DTS.

While signals from DTS-laser disc or CD are playing in another Surround mode, you cannot switch to digital input or from digital input to analog input.

### Caution for 96kHz PCM-audio signal:

This signal can be played when a DVD-player or DAT-player connected to the SR4200 is capable of 96 kHz PCM output. For details, refer to the player's operation manual.

The signal can be played when STEREO or AUTO has been selected for the Surround mode.

Some DVD formatted discs featured copy protect. When use such disc, 96 kHz PCM signal is not output from the DVD player. For details, refer to the player's operation manual.

### The relation between the selected surround mode and the input signal

The surround mode is selected with the surround mode buttons of the SR4200 or the remote control unit. However, the sound from the speakers depend upon the relationship between the selected surround mode and the input signal. They are as follows;

SURROUND MODE	INPUT SIGNAL	OUTPUT				FLUORESCENT INDICATOR	
		L/R	LS/RS	C	SW	FORMAT STATUS & SURROUND MODE	TEMPORARY DISPLAY STATUS
AUTO	DOLBY DIGITAL(5.1CH)	○	○	○	○	□□ DIGITAL , AUTO	>AUTO>
	DOLBY DIGITAL(2CH)	○	—	—	○	□□ DIGITAL , AUTO	>AUTO>
	DOLBY DIGITAL(2CH:Lt/Rt)	○	○	○	○	□□ DIGITAL, MOVIE, AUTO	>AUTO>
	96KHZ PCM	○	—	—	—	PCM, STEREO , AUTO	>AUTO>
	PCM(AUDIO)	○	—	—	○	PCM, STEREO , AUTO	>AUTO>
	ANALOG	○	—	—	○	STEREO , AUTO	>AUTO>
	DTS(5.1CH)	○	○	○	○	dts , AUTO	>AUTO>
STEREO	DOLBY DIGITAL(5.1CH)	○	—	—	○	□□ DIGITAL,STEREO	>STEREO>
	DOLBY DIGITAL(2CH)	○	—	—	○	□□ DIGITAL,STEREO	>STEREO>
	DOLBY DIGITAL(2CH:Lt/Rt)	○	—	—	○	□□ DIGITAL,STEREO	>STEREO>
	96KHZ PCM	○	—	—	—	PCM, STEREO	>STEREO>
	PCM(AUDIO)	○	—	—	○	PCM, STEREO	>STEREO>
	ANALOG	○	—	—	○	STEREO	>STEREO>
	DTS(5.1CH)	○	—	—	○	dts , STEREO	>STEREO>
□□ MOVIE	DOLBY DIGITAL(5.1CH)	○	○	○	○	□□ DIGITAL	>DOLBY D>
	DOLBY DIGITAL(2CH)	○	○	○	○	□□ DIGITAL, MOVIE	>DOLBY PLII>
	DOLBY DIGITAL(2CH:Lt/Rt)	○	○	○	○	□□ DIGITAL, MOVIE	>DOLBY PLII>
	96KHZ PCM	—	—	—	—	(PCM), □□, MOVIE	>DOLBY PLII>
	PCM(AUDIO)	○	○	○	○	PCM, □□, MOVIE	>DOLBY PLII>
	ANALOG	○	○	○	○	□□, MOVIE	>DOLBY PLII>
	DTS(5.1CH)	—	—	—	—	(dts), □□, MOVIE	>DOLBY PLII>
□□ MUSIC	DOLBY DIGITAL(5.1CH)	○	○	○	○	□□ DIGITAL	>DOLBY D>
	DOLBY DIGITAL(2CH)	○	○	○	○	□□ DIGITAL, MUSIC	>DOLBY PLII>
	DOLBY DIGITAL(2CH:Lt/Rt)	○	○	○	○	□□ DIGITAL, MUSIC	>DOLBY PLII>
	96KHZ PCM	—	—	—	—	(PCM), □□, MUSIC	>DOLBY PLII>
	PCM(AUDIO)	○	○	○	○	PCM, □□, MUSIC	>DOLBY PLII>
	ANALOG	○	○	○	○	□□, MUSIC	>DOLBY PLII>
	DTS(5.1CH)	—	—	—	—	(dts), □□, MUSIC	>DOLBY PLII>
□□ PRO LOGIC	DOLBY DIGITAL(5.1CH)	○	○	○	○	□□ DIGITAL	>DOLBY D>
	DOLBY DIGITAL(2CH)	○	○	○	○	□□ DIGITAL, □□ PRO LOGIC	>DOLBY PL>
	DOLBY DIGITAL(2CH:Lt/Rt)	○	○	○	○	□□ DIGITAL, □□ PRO LOGIC	>DOLBY PL>
	96KHZ PCM	—	—	—	—	(PCM), □□ PRO LOGIC	>DOLBY PL>
	PCM(AUDIO)	○	○	○	○	PCM, □□ PRO LOGIC	>DOLBY PL>
	ANALOG	○	○	○	○	□□ PRO LOGIC	>DOLBY PL>
	DTS(5.1CH)	—	—	—	—	(dts), □□ PRO LOGIC	>DOLBY PL>
DTS	DOLBY DIGITAL(5.1CH)	—	—	—	—	(□□), dts	>DTS>
	DOLBY DIGITAL(2CH)	—	—	—	—	(□□), dts	>DTS>
	DOLBY DIGITAL(2CH:Lt/Rt)	—	—	—	—	(□□), dts	>DTS>
	96KHZ PCM	—	—	—	—	(PCM), dts	>DTS>
	PCM(AUDIO)	—	—	—	—	(PCM), dts	>DTS>
	DTS(5.1CH)	○	○	○	○	dts	>DTS>
	MOVIE HALL MATRIX GAME	DOLBY DIGITAL(5.1CH)	—	—	—	—	(□□), DSP, MOVIE/ HALL/ MATRIX/ GAME
DOLBY DIGITAL(2CH)		—	—	—	—	(□□), DSP, MOVIE/ HALL/ MATRIX/ GAME	>MOVIE/ HALL/ MATRIX/ GAME>
DOLBY DIGITAL(2CH:Lt/Rt)		—	—	—	—	(□□), DSP, MOVIE/ HALL/ MATRIX/ GAME	>MOVIE/ HALL/ MATRIX/ GAME>
96KHZ PCM		—	—	—	—	(PCM), DSP, MOVIE/ HALL/ MATRIX/ GAME	>MOVIE/ HALL/ MATRIX/ GAME>
PCM(AUDIO)		○	○	○	○	PCM, DSP, MOVIE/ HALL/ MATRIX/ GAME	>MOVIE/ HALL/ MATRIX/ GAME>
ANALOG		○	○	○	○	DSP, MOVIE/ HALL/ MATRIX/ GAME	>MOVIE/ HALL/ MATRIX/ GAME>
DTS(5.1CH)		—	—	—	—	(dts),DSP, MOVIE/ HALL/ MATRIX/ GAME	>MOVIE/ HALL/ MATRIX/ GAME>
VIRTUAL	DOLBY DIGITAL(5.1CH)	—	—	—	—	(□□), DSP, VIRTUAL	>VIRTUAL>
	DOLBY DIGITAL(2CH)	—	—	—	—	(□□), DSP, VIRTUAL	>VIRTUAL>
	DOLBY DIGITAL(2CH:Lt/Rt)	—	—	—	—	(□□), DSP, VIRTUAL	>VIRTUAL>
	96KHZ PCM	—	—	—	—	(PCM), DSP, VIRTUAL	>VIRTUAL>
	PCM(AUDIO)	○	—	—	○	PCM, DSP, VIRTUAL	>VIRTUAL>
	ANALOG	○	—	—	○	DSP, VIRTUAL	>VIRTUAL>
	DTS(5.1CH)	—	—	—	—	(dts),DSP, VIRTUAL	>VIRTUAL>
5-STEREO	DOLBY DIGITAL(5.1CH)	○	○	○	○	□□	>5-STEREO>
	DOLBY DIGITAL(2CH)	○	○	○	○	□□	>5-STEREO>
	DOLBY DIGITAL(2CH:Lt/Rt)	○	○	○	○	□□	>5-STEREO>
	96KHZ PCM	—	—	—	—	(PCM)	>5-STEREO>
	PCM(AUDIO)	○	○	○	○	PCM	>5-STEREO>
	ANALOG	○	○	○	○		>5-STEREO>
	DTS(5.1CH)	○	○	○	○	dts	>5-STEREO>

**Note:**

- Dolby Digital (2 ch: Lt/Rt): signal with Dolby Surround flag Speakers are full set.
- When □□, dts or PCM is blinking, the selected surround mode is unavailable for input signal. Select the other appropriate surround mode to playback.
- No sound outputs from the surround speaker, center speaker and subwoofer if the DVD disc has no surround data.

L/R : Front speaker ( ) : The indicator blinks  
 LS/RS : Surround speaker  
 C : Center speaker  
 SW : Sub woofer speaker

# TROUBLE SHOOTING

If the unit does not operate properly, check items shown in the following table. If your trouble cannot be recovered with the remedy actions listed in the following table, malfunction of the internal circuitry is suspected; immediately unplug the power cable and contact your dealer, nearest Marantz distributor or the Marantz Service Center in your country.

In case of trouble, check the following before calling for service:

1. Are the connections made properly ?
2. Are you operating the unit properly following user's guide ?
3. Are the power amplifiers and speaker working properly ?

SYMPTOM	CAUSE	REMEDY
SR4200 cannot be turned up.	The power plug is not connected.	Connect the power plug to the outlet.
No sound and picture are output even when power is on.	Mute is on. The input cable is not connected correctly. The master volume control is turned all the way down. The function selector position is wrong.	Cancel mute using the remote control unit. See the connection diagram and connect the cables correctly. Adjust the master volume. Select correct position.
Speaker does not outputting any sound.	The headphones are connected to the headphone jack.	Disconnect the headphones. (Speakers will not output sound when headphones are connected.)
Sound and pictures from other than equipment selected with the function selector.	Input cable connected incorrectly.	Connect the cable correctly by referring to the connection diagram.
Sound from the wrong channel is output from the speaker.	Speaker cable connected incorrectly.	Connect the cable correctly by referring to the connection diagram.
No sound is output from the center speaker.	The center speaker cable connection is incomplete. STEREO has been selected for Surround mode.  Center = NONE has been selected in SETUP mode.	Connect the cable correctly. When STEREO is selected for Surround mode, no sound will be output from the center speaker. Set another Surround mode. Make the correct setting.
No sound is output from the surround speakers.	The surround speaker cable connection is incomplete. STEREO has been selected for Surround mode.  Surround = NONE has been selected in SETUP mode.	Connect the cable correctly. When STEREO has been selected for Surround mode, no sound will be output from the surround speaker. Set another Surround mode. Make the correct setting.
No output to Sub Woofer Out.	Sub-woofer = NO has been selected in SETUP mode.	Select Sub-woofer = YES.
Surround mode cannot be changed.	The headphones are connected to the jack.	Disconnect the headphones. (When headphones are connected, Surround mode will be fixed to STEREO.)
Noise is produced during DTS-encoded CD or laser disc play.	Analog has been selected for input.	Be sure to perform digital connection, select digital input, then play.
DTS sources cannot be played.	Surround mode is set to DOLBY. The DVD or LD player is not DTS digital out capable.	Select other mode. Use a player which responds to DTS-digital out.
Player skips during play of a DTS source and produces noise.	Data error occurred during player skip.	Set Surround mode to DTS.
A 96kHz PCM signal cannot be played.	The disc player is not 96kHz PCM digital out capable. Surround mode is set to other than STEREO and AUTO.	Use a player that responds to 96kHz PCM digital out. Set Surround mode to STEREO or AUTO.
A normal PCM signal (CD or laser disc) cannot be played.	Surround mode is set to DTS.	Select other mode.
A Dolby Digital signal cannot be played.	Surround mode is set to DTS.	Select other mode.
A specific channel does not produce output.	Nothing recorded on source.	Check the encoded channel on the source side.
FM or AM reception fails.	Antenna connection is incomplete.	Correctly connect the indoor FM and AM antennas to FM and AM antenna outlets.
Noise is heard during AM reception.	Reception is affected by other electrical fields.	Try changing location where the AM indoor antenna is set up.
Noise is heard during FM reception.	The radio waves from the broadcasting station are weak.	Install an FM outdoor antenna.
Cannot get programmed station when the PRESET button is pressed.	Preset data has been erased.	Disconnecting power plug for long periods of time will erase preset data. If that happens, input the preset data again.
Nothing appears on the remote commander display.	Batteries are consumed.	Replace all the batteries with new ones.
Control with the remote control unit fails.	Batteries are consumed. Remote controller's function-key setting is wrong. The distance between this SR4200 and the remote commander is too far. Something is blocking SR4200 and the remote commander.	Replace all the batteries with new ones. Select different position from which equipment will be controlled. Move closer to this SR4200. Remove offending object.



### GENERAL MALFUNCTION

If the equipment malfunctions, this may be because an electrostatic discharge or AC line interference has corrupted the information in the equipment memory circuits. Therefore:

- disconnect the plug from the AC line supply
- after waiting at least three minutes, reconnect the plug to the AC line supply
- re-attempt to operate the equipment

### HOW TO RESET THE UNIT

Should the operation or display seem to be abnormal, reset the unit with the following procedure.

Press **POWER** button [2] to set SR4200 in standby mode, then press and hold the **F/P** [14] until SR4200 is turned on.

Remember that the procedure will reset the settings of the function selector, Surround mode, delay time, TUNER PRESET etc., to their initial settings.

#### Memory backup

- In case a power outage occurs or the power cord is accidentally unplugged, the SR4200 is equipped with a backup function to prevent memory data such as the preset memory from being erased.

The memory functions are backed up for up to about one week.

#### NOTE:

First of all keep SR4200 Standby or Powered-on more than 6 hours, to sufficient time for memory back up.

# SETUP CODES

## CD

Aiwa	0151, 0184
Burmester	0447
California Audio Labs	0056, 0330
Carver	0184, 0206, 0326, 0464
DKK	0027
Denon	0030
Emerson	0332
Fisher	0201, 0206
Garrard	0420, 0447
Genexxa	0059, 0332
Harman/Kardon	0184, 0200
Hitachi	0059
JVC	0099
Kenwood	0055, 0064, 0217
Krell	0184
LXI	0332
Linn	0184
Luxman	0062, 0120, 0293, 0354, 0355, 0457, 0459, 0510, 0516
MCS	0056
MTC	0447
Magnavox	0184, 0332
Marantz	0056, 0184, 0207, 1207, 0999,
Mission	0184
NAD	0046, 0326, 0343, 0747, 0748
NSM	0184
Nakamichi	0106, 0174, 0466, 0471, 0691
Nikko	0201
Onkyo	0128
Optimus	0027, 0059, 0064, 0172, 0206, 0332, 0447, 0464, 0495
Panasonic	0056, 0330
Parasound	0447
Philips	0184
Pioneer	0059, 0271, 0332, 0495
Polk Audio	0184
Proton	0184
QED	0184
Quasar	0056
RCA	0059, 0080, 0206, 0332, 0495, 0791
Realistic	0206, 0207, 0447
Rotel	0184, 0447
SAE	0184
Sansui	0184, 0332
Sanyo	0206
Scott	0332
Sears	0332
Sharp	0064, 0207
Sherwood	0207
Sonic Frontiers	0184
Sony	0027, 0212
Soundesign	0172
Tascam	0447
Teac	0201, 0207, 0420, 0447
Technics	0056, 0330
Toshiba	0046, 0326
Victor	0099
Wards	0080, 0184
Yamaha	0063, 0214
Yorx	0488

## MD PLAYERS

Denon	1900
Kenwood	1708, 1853
Marantz	1207
Onkyo	1895
Optimus	1090
Pioneer	1090
Sharp	1888
Sherwood	1094
Sony	1517
Yamaha	1915

## CDR

Marantz	0999
---------	------

## TAPE

Aiwa	0056, 0224
Carver	0056
Denon	0103
Garrard	0335, 0336
Harman/Kardon	0056, 0209
JVC	0271, 0300
Kenwood	0097
Magnavox	0056
Marantz	0056
NAD	0171
Onkyo	0162, 0309
Optimus	0054, 0247
Panasonic	0256
Philips	0056
Pioneer	0054, 0126, 0247
Polk Audio	0056
RCA	0054, 0247
Samsung	0418, 0419
Sansui	0056
Sony	0197, 0270, 0318
Teac	0307, 0335, 0336, 0418, 0419
Technics	0256
Victor	0300
Wards	0054
Yamaha	0121, 0124

## SAT (DSS)

AlphaStar	0799
Echostar	0802, 1032
Expressvu	0802
General Instrument	0388, 0654, 0896
HTS	0802
Hitachi	0846
Hughes Network Systems	0776
JVC	0802
Jerrold	0388, 0654
Magnavox	0749, 0751
Memorex	0751
Next Level	0896
Panasonic	0728
Philips	0749, 0751, 1103
Primestar	0388, 0654
RCA	0170, 0419, 0593, 0882
Radio Shack	0896
Sony	0666
Star Choice	0896
Toshiba	0776, 0817
Uniden	0749, 0751
Zenith	0883

**TV**

AOC .....	0046, 0057
Admiral .....	0120, 0490
Aiko .....	0119
Akai .....	0057
Alaron .....	0206
Ambassador .....	0204
America Action .....	0207
Anam .....	0207
Audiovox .....	0119, 0207, 0478, 0650
Baysonic .....	0207
Belcor .....	0046
Bell & Howell .....	0043, 0181
Bradford .....	0207
Brockwood .....	0046
Broksonic .....	0263, 0490
CXC .....	0207
Candle .....	0057, 0083
Carnivale .....	0057
Carver .....	0081
Celebrity .....	0027
Cineral .....	0119, 0478
Citizen .....	0057, 0083, 0087, 0119
Concerto .....	0083
Contec .....	0207
Craig .....	0207
Crosley .....	0081
Crown .....	0207
Curtis Mathes .....	0043, 0057, 0074, 0078, 0081, 0083, 0087, 0120, 0172, 0181, 0193, 0478, 1174, 1374
Daewoo .....	0046, 0119, 0478, 0650, 0651
Daytron .....	0046
Denon .....	0172
Dumont .....	0044, 0046
Dwin .....	0747, 0801
Electroband .....	0027
Emerson .....	0046, 0181, 0204, 0205, 0206, 0207, 0263, 0490, 0650, 0651
Envision .....	0057
Fisher .....	0181
Fujitsu .....	0206, 0710
Funai .....	0206, 0207
Futuretech .....	0207
GE .....	0074, 0078, 0120, 0205, 0478, 1174, 1374
Gibraltar .....	0044, 0046, 0057
GoldStar .....	0046, 0057, 0083, 0205
Gradiente .....	0080, 0083
Grunpy .....	0206, 0207
Hallmark .....	0205
Harley Davidson .....	0206
Harman/Kardon .....	0081
Harvard .....	0207
Hitachi .....	0043, 0083, 0172
Infinity .....	0081
Inteq .....	0044
JBL .....	0081
JCB .....	0027
JVC .....	0080
KEC .....	0207
KTV .....	0057, 0207
Kenwood .....	0046, 0057
LG .....	0083
LXI .....	0074, 0081, 0181, 0183, 0205
Logik .....	0043
Luxman .....	0083
MGA .....	0046, 0057, 0177, 0205
MTC .....	0046, 0057, 0083, 0087
Magnavox .....	0057, 0081, 0206, 1281
Majestic .....	0043
Marantz .....	0057, 0081, 1581
Matsushita .....	0277
Megatron .....	0172, 0205
Memorex .....	0043, 0083, 0177, 0181, 0205, 0206, 0277, 0490
Midland .....	0044, 0074, 0078
Mitsubishi .....	0046, 0120, 0177, 0205
Motorola .....	0120
Multitech .....	0207
NAD .....	0183, 0193, 0205
NEC .....	0046, 0057, 0083
NTC .....	0119
Nikko .....	0057, 0119, 0205
Onwa .....	0207
Optimus .....	0181, 0193, 0277
Optonica .....	0120, 0192
Orion .....	0206, 0263, 0490
Panasonic .....	0078, 0277
Penney .....	0046, 0057, 0074, 0078, 0083, 0087, 0183, 0205, 1374
Philco .....	0046, 0057, 0081, 0172, 0490
Philips .....	0081
Pilot .....	0046, 0057
Pioneer .....	0193, 0706
Portland .....	0046, 0119
Prism .....	0078
Proscan .....	0074
Proton .....	0205
Pulsar .....	0044, 0046
Quasar .....	0078, 0192, 0277
RCA .....	0046, 0074, 0078, 0117, 0120, 0706, 1074, 1174, 1274, 1374, 1474
Radio Shack .....	0046, 0057, 0074, 0083, 0181, 0192, 0205, 0207
Realistic .....	0046, 0057, 0083, 0181, 0192, 0205, 0207
Runco .....	0044, 0057, 0630
SSS .....	0046, 0207
Sampo .....	0057
Samsung .....	0046, 0057, 0083, 0087, 0205
Sansei .....	0478
Sansui .....	0490
Sanyo .....	0181
Scimitsu .....	0046
Scotch .....	0205
Scott .....	0046, 0205, 0206, 0207, 0263
Sears .....	0074, 0081, 0083, 0181, 0183, 0205, 0206
Semivox .....	0207
Semp .....	0183
Sharp .....	0120, 0192, 0715
Shogun .....	0046
Signature .....	0043
Sony .....	0027
Soundesign .....	0205, 0206, 0207
Starlite .....	0207
Supreme .....	0027
Sylvania .....	0057, 0081
TMK .....	0083, 0204, 0205
TNCi .....	0044
Tandy .....	0120
Technics .....	0078, 0277
Technol Ace .....	0206
Techwood .....	0078, 0083
Teknika .....	0043, 0046, 0081, 0083, 0087, 0119, 0177, 0206, 0207
Telefunken .....	0083
Toshiba .....	0087, 0181, 0183, 1283
Vector Research .....	0057
Victor .....	0080
Vidikron .....	0081
Vidtech .....	0046, 0205
Wards .....	0043, 0046, 0057, 0081, 0083, 0192, 0205, 0206
White Westinghouse .....	0490, 0650, 0651
Yamaha .....	0046, 0057
Zenith .....	0043, 0044, 0119, 0490, 0651

**VCR**

Admiral ..... 0075, 0236  
Adventura ..... 0027  
Aiko ..... 0305  
Aiwa ..... 0027, 0064  
America Action ..... 0305  
American High ..... 0062  
Asha ..... 0267  
Audiovox ..... 0064  
Beaumarck ..... 0267  
Bell & Howell ..... 0131  
Broksonic ..... 0148, 0211, 0236, 0506  
CCE ..... 0099, 0305  
Calix ..... 0064  
Canon ..... 0062  
Carver ..... 0108  
Cineral ..... 0305  
Citizen ..... 0064, 0305  
Colt ..... 0099  
Craig ..... 0064, 0074, 0099, 0267  
Curtis Mathes ..... 0062, 0087, 0189  
Cybernex ..... 0267  
Daewoo ..... 0072, 0305  
Denon ..... 0069  
Dynatech ..... 0027  
Electrohome ..... 0064  
Electroponic ..... 0064  
Emerex ..... 0059  
Emerson ..... 0027, 0064, 0070, 0148, 0211, 0236, 0305, 0506  
Fisher ..... 0074, 0131  
Fuji ..... 0062  
Funai ..... 0027  
GE ..... 0062, 0075, 0087, 0267  
Garrard ..... 0027  
Go Video ..... 0459  
GoldStar ..... 0064  
Gradiente ..... 0027  
HI-Q ..... 0074  
Harley Davidson ..... 0027  
Harman/Kardon ..... 0108  
Harwood ..... 0099  
Hitachi ..... 0027, 0069  
Hughes Network Systems ..... 0069  
JVC ..... 0094  
KEC ..... 0064, 0305  
KLH ..... 0099  
Kenwood ..... 0094  
Kodak ..... 0062, 0064  
LXI ..... 0064  
Lloyd's ..... 0027  
Logik ..... 0099  
MEI ..... 0062  
MGA ..... 0070, 0267  
MGN Technology ..... 0267  
MTC ..... 0027, 0267  
Magnasonic ..... 0305  
Magnavox ..... 0027, 0062, 0066, 0108  
Magnin ..... 0267  
Marantz ..... 0062, 0108, 1408  
Marta ..... 0064  
Matsushita ..... 0062, 0189  
Memorex ..... 0027, 0062, 0064, 0066, 0074, 0075, 0131, 0189,  
0236, 0267, 0506, 1064, 1189, 1289  
Minolta ..... 0069  
Mitsubishi ..... 0070, 0075, 0094  
Motorola ..... 0062, 0075  
Multitech ..... 0027, 0099  
NAD ..... 0085

NEC ..... 0094, 0131  
Nikko ..... 0064  
Noblex ..... 0267  
Olympus ..... 0062  
Optimus ..... 0064, 0075, 0085, 0131, 0189, 0459, 1075, 1089,  
1189, 1289  
Orion ..... 0211, 0236, 0506  
Panasonic ..... 0062, 0189, 0252, 0643, 1089, 1189, 1289  
Penney ..... 0062, 0064, 0069, 0267  
Pentax ..... 0069  
Philco ..... 0062, 0236, 0506  
Philips ..... 0062, 0108, 0645, 1108, 1208  
Pilot ..... 0064  
Pioneer ..... 0085, 0094  
Polk Audio ..... 0108  
Profitronic ..... 0267  
Proscan ..... 0087  
Protec ..... 0099  
Pulsar ..... 0066  
Quasar ..... 0062, 0189, 1189  
RCA ..... 0062, 0069, 0075, 0085, 0087, 0267  
Radio Shack ..... 0027, 1064  
Radix ..... 0064  
Randex ..... 0064  
Realistic ..... 0027, 0062, 0064, 0074, 0075, 0131  
ReplayTV ..... 0641, 0643  
Runco ..... 0066  
STS ..... 0069  
Samsung ..... 0072, 0267  
Sanky ..... 0066, 0075  
Sansui ..... 0027, 0094, 0236, 0506  
Sanyo ..... 0074, 0131, 0267  
Scott ..... 0070, 0072, 0148, 0211  
Sears ..... 0027, 0062, 0064, 0069, 0074, 0131  
Semp ..... 0072  
Sharp ..... 0075  
Shintom ..... 0099  
Shogun ..... 0267  
Singer ..... 0099  
Sony ..... 0027, 0059, 0062, 1059  
Sylvania ..... 0027, 0062, 0070, 0108  
Symphonic ..... 0027  
TMK ..... 0267  
Teac ..... 0027  
Technics ..... 0062, 0189  
Teknika ..... 0027, 0062, 0064  
Thomas ..... 0027  
Tivo ..... 0645  
Toshiba ..... 0070, 0072  
Totevision ..... 0064, 0267  
Unitech ..... 0267  
Vector ..... 0072  
Video Concepts ..... 0072  
Videasonic ..... 0267  
Wards ..... 0027, 0062, 0069, 0074, 0075, 0087, 0099, 0108, 0267  
White Westinghouse ..... 0099, 0236, 0305  
XR-1000 ..... 0027, 0062, 0099  
Zenith ..... 0027, 0066, 0236, 0506

**DVD**

Aiwa ..... 0668  
Apex ..... 0699  
Denon ..... 0517, 0661  
Fisher ..... 0697  
GE ..... 0549  
Harman/Kardon ..... 0609  
Hitachi ..... 0691  
Hiteker ..... 0699  
JVC ..... 0585, 0650  
Kenwood ..... 0561, 0709  
Magnavox ..... 0530, 0702  
Marantz ..... 0566  
Mitsubishi ..... 0548  
Onkyo ..... 0530, 0654  
Optimus ..... 0598  
Oritron ..... 0678  
Panasonic ..... 0517, 0659  
Philips ..... 0530, 0566  
Pioneer ..... 0552, 0598, 0659  
Proscan ..... 0549  
RCA ..... 0549, 0598  
Samsung ..... 0600  
Sharp ..... 0657  
Sony ..... 0560  
Technics ..... 0517  
Theta Digital ..... 0598  
Toshiba ..... 0530  
Yamaha ..... 0517, 0572  
Zenith ..... 0530, 0618

# TECHNICAL SPECIFICATIONS

## FM TUNER SECTION

Frequency Range .....	87.5 - 108.0 MHz
Usable Sensitivity .....	IHF 1.8 $\mu$ V/16.4 dBf
Signal to Noise Ratio .....	Mono/Stereo 70/65 dB
Distortion .....	Mono/Stereo 0.2/0.3 %
Stereo Separation .....	1 kHz 45 dB
Alternate Channel Selectivity .....	$\pm$ 300 kHz 60 dB
Image Rejection .....	98 MHz 70 dB
Tuner Output Level .....	1 kHz, $\pm$ 40 kHz Dev 600 mV

## AM TUNER SECTION

Frequency Range .....	LW: 152 - 282 kHz, MW: 531 - 1602 kHz
Signal to Noise Ratio .....	50 dB
Usable Sensitivity .....	Loop 400 $\mu$ V/m
Distortion .....	400 Hz, 30 % Mod. 0.5 %
Selectivity .....	$\pm$ 18 kHz 60 dB

## AUDIO SECTION

Maximum Power Output (6 ohms / EIAJ)	
Front .....	100W
Center .....	100W
Surround .....	100W
Continuous Power Output (8 ohms / 20 Hz - 20 kHz)	
Front .....	70W
Center .....	70W
Surround .....	70W
THD Front (20 Hz - 20 kHz) .....	8 ohms 0.09 %
Input Sensitivity/Impedance	
Linear .....	316 mV/ 47 Kohms
Signal to Noise Ratio	
Linear .....	99 dB

## VIDEO

Input Level/Impedance .....	1 Vp-p/ 75 ohms
Output Level/Impedance .....	1 Vp-p/ 75 ohms

## GENERAL

Power Requirement .....	AC 230 V 50 Hz
Power Consumption .....	280 W
Dimension (MAX)	
Width .....	440 mm
Height .....	164 mm
Depth .....	365 mm
Weight .....	9.7 Kg

## ACCESSORIES

Remote Control Unit RC5200SR .....	1
AAA-size batteries .....	2
FM Lead Type Antenna .....	1
AM Loop Antenna .....	1
AC Power Cord .....	1
Registration Card .....	1
User Guide .....	1

Specifications subject to change without prior notice.

COUNTRY	COMPANY	ADDRESS
ALGERIE	Azur 2000	8, Lotissement Ben Hatadi, Alger, Algeria
ARMENIA	NGYIG Ltd.	47 A/75 St. Lalaiants, 375000 Yerevan, Armenia
AUSTRALIA	Jamo Australia Pty. Ltd.,	24 Lionel Road, Mt. Waverley, VIC 3149, Australia
AUSTRIA	Huber & Prohaska GmbH	Taborstraße 95 / Ladestraße 1, Gebäude Hangartner, A-1200 Wien, Austria
BAHREIN	Ambassador Stores	P.O. Box 237,141, Government Avenue, Manama,Bahrein
BANGLADESH	Target	1078, Ramjoy Mohanja Lane Asadgonj, Chittagong 4000, Bangladesh
BELGIUM	Van der Heyden Audio N.V.	Brusselbaan 278, 9320 Erembodegem, Belgium
BULGARIA	Ariescommerce GmbH	Makedonia Blvd. 16, 1606 Sofia, Bulgaria
CANADA	Lenbrook Industries Limited	633 Granite Court, Pickering, Ontario
CHINA	Guang Chang Audio International Co., Ltd.	No.38 Yushan Road, ShiQiao, Pan Yu, Guang Dong, China
CYPRUS	Empire Hifi systems Ltd.	P.O. Box 5604, Nicosia, Cyprus
CZECH REPUBLIC	Audio International	Sokolska 41, 67902 Rajecko, OKR,Blansko, Czech Republic
DENMARK	Audio Nord	Dali Allé 1, 9610 Noerager, Denmark
DUBAI	V.V. & SONS	P.O. Box 105, Dubai, U.A.E.
EGYPT	Solimco	9, El Attibaa St. Doki, Cairo, Egypt
ESTONIA	HiFi Club Estonia	Ehte 4, 90503 Haapsalu, Estonia
F.Y.R.O.M.	T.P. KODI	ul.Cedomir Kantargiev 21a, Skopje, Former Yugoslavian Republic of Macedonia
FINLAND	Audio Nord	Uudenmaankatu 4-6, Helsinki SF-00120, Finland
FRANCE	Marantz France	A division of Marantz Europe B.V., P.O. Box 301, 92 156 Suresnes Cedex, France
GERMANY	Marantz Deutschland	Hakenbusch 3, 49078 Osnabrück, Germany
GREECE	Adamco S.A.	188, Hippocratous Street, 11471 Athens, Greece
HEADQUARTERS EUROPE:	Marantz Europe B.V.	Building SFF-2, P.O. Box 80002, 5600 JB Eindhoven, The Netherlands
HONG KONG	Marantz Asia Ltd.	Unit 1706, Metroplaza II, 223 Hing Fong Road, Kwai Fong, N.T., Kowloon, Hong Kong
HUNGARY	Infovox Ltd.	Terez Krt.31, 1067 Budapest, Hungary
ICELAND	ID Electronics Ltd.	Armula 38, 108 Reykjavik, Iceland
INDIA	NOVA Audio Private	8,Punam Co-op.Society 29/30 Road#5, Union Park MUMBAI 400052, India
IRAN	Home Co.	5th floor no 878 Philips Building Enghelab ave, P.O. 11365/7844 Tehran, Iran
IRELAND	Marantz Ireland	Clonskeagh, Dublin 14, Ireland
ISRAEL	Elmor Ltd.	52 Heh Beiyar Street, Kikar Hamedina, Tel Aviv, Israel
ITALY	Marantz Italy	Via Casati 23, 20052 Monza (Milano), Italy, Servizio Consumatori 1678-20026, Numero Verde
IVORY COAST	Hifivoir	B.P. 2428, Abidjan 01, Ivory Coast
JAPAN	Marantz Japan Inc.	35-1 Sagami Ohno 7-Chome, Sagamihara-shi, Kanagawa 228-8505, Japan
KOREA	Mk Enterprises Ltd.	121-210, 2F Shinhan Bldg., 247-17 Seokyo-dong, Mapo-ku, Seoul, Korea
KUWAIT	alAlamiah Electronics Intl.	P.O. Box 8196, Salmiah 22052, Kuwait
LATVIA	Ace Ltd.	61, LacPlesa Str., Riga LV 1011, Latvia
LEBANON	AZ Electronics S.A., 1,	P.O. Box 11 2833, Beirut, Lebanon
LITHUANIA	Accapella Ltd.	Ausros, Vartu G/5, Pasazo SKG., 2001 Vilnius, Lithuania
MALAYSIA	Wo Kee Hong Electronics Sdn. Bhd.	Suite 8.1, Level 8, Menara Genesis, No. 33, Jalan Sultan Ismail, 50250 Kuala Lumpur, Malaysia
MALTA	Doneo Co Ltd.	78 The Strand, Sliema SLM07, Malta
MAURITIUS	SKR Electronics Ltd.	P.O. Box 685, Bell Village, Port Louis, Mauritius
MILITARY MARKET EUROPE	PASCO GmbH	PO BOX 1280, Sandhausen 69200, Germany
NETHERLANDS	Marantz Domestic Sales	A division of Marantz Europe B.V., Building SFF2, P.O. Box 80002, 5600 JB Eindhoven, The Netherlands
NEW ZEALAND	Wildash Audio Systems	14 Malvern Road, Mt. Albert, Auckland, New Zealand
NORWAY	Audio Nord	Sandkerveien 64, Oslo 0483, Norway
OMAN	Mustafa & Jawad Trading CO.	P.O. Box 1918, Ruwi, Oman
POLAND	Philips Polska Sp. z.o.o.	Al.Jerozolimskie 195b, 02 222 Warszawa, Poland
PORTUGAL	Corel2	Comércio de Electrónica Lda., Av. Luís Bivar, No 85 A, 1050 Lisboa, Portugal
PROFESSIONAL EUROPE	Marantz Professional Products	Kingsbridge House, Padbury Oaks, 575-583 Bath Road, Longford, Middlesex UB7 0EH, U.K.
PROFESSIONAL U.S.A.	Marantz Professional Products	Distributed by: Superscope Technologies Inc., 1000 Corporate Blvd. Ste.D, Aurora, Illino
QATAR	Almana & Partners W.W.L.	P.O. Box 49, Doha, Qatar
REUNION	Vision +	180 Rue du Marechal Leclerc, 97400 Saint Denis, Ile de la Reunion
ROMANIA	Nova Music Entertainment	5, Zagazului Str. Bl.1G,apt.18, sector 1,Bucharest, Romania
RUSSIA	Absolute Audio	7/2, Montazhnaya Street, 107497 Moscow, Russia
SAUDI ARABIA	Adawlia Univ. Electr. Apl	P.O. Box 2154, Alkhobar 31952, Saudi Arabia
SINGAPORE	Wo Kee Hong Distribution PTE Ltd.	130 Joo Seng Road, #03-02 Olivine Building, Singapore 368357
SLOVAKIA	Bis Audio s.r.o.	Nam. SNP 10, 96001 Zvolem, Slovakia
SLOVENIA	Bofex	Smartinska 152, HALA V/3, 61000 Ljubljana, Slovenia
SOUTH AFRICA	Coherent Imports (PTY) Ltd.	P.O. Box 1614, Alberton, 1450, South Africa
SPAIN	Marantz Spain	Martinez Villergas 2, Apartado 2065, Madrid 28027, Spain
SRI LANKA	The listening Room	Mezzanine Floor, The Landmark 385, Galle Road, Colombo - 3, Sri Lanka
SWEDEN	Audio Nord	Almedalsvagen 4, Gotenborg 402-23, Sweden
SWITZERLAND	Sound Company AG	Postfach, 8010 Zürich, Switzerland
SYRIA	Hamzeh & Partners	Hafez Ibrahim Str. No 117, Damascus Shalan, Syria
TAHITI	Covecolor	Av. Prince Hinoi, Cours de l'union sacré, P.O. Box 2334, Papeete, Tahiti
TAIWAN	Pai-Yuing Co. Ltd.	6th No 148 Sung Kiang Road, Taipei 10429, Taiwan R.O.C.
THAILAND	MRZ Standard Co. Ltd.	746-750 Mahachai Road, Wangburapa, Bangkok 10200, Thailand
TUNESIA	Societe EDEVIG	40, Avenue du Golfe Arabe, El Menzah, 1004, Tunesia
TURKEY	Türk Philips Ticaret A.S.	Yukari Dudullu Organize sanayi Bolgesi, 2.Cadde no.28, 81260 Umraniye-Istanbul, Turkey
U.K.	Marantz Hifi UK Ltd.	Kingsbridge House, Padbury Oaks, 575-583 Bath Road, Longford, Middlesex UB7 0EH, U.K.
U.S.A.	Marantz America Inc.	440 Medinah Road, Roselle, IL 60172, U.S.A.
YUGOSLAVIA	ITM Company	Omladinskih Brigada 86, 11070 Belgrade, Yugoslavia
EXPORT	Marantz Domestic Sales	A division of Marantz Europe BV,Building SFF2, P.O. Box 80002, 5600 JB Eindhoven, The Netherlands

www.marantz.com

Manufactured under license from Dolby Laboratories. "Dolby", "Pro Logic", and the double-D symbol are trademarks of Dolby Laboratories. Confidential unpublished works. Copyright 1992-1997 Dolby Laboratories. All rights reserved.

"DTS" and "DTS Digital Surround" are registered trademarks of Digital Theater Systems, Inc.

**marantz**® is a registered trademark.

